WHEATSTONE GIBRALTAR DIGITAL AUDIO NETWORK SYSTEM

TECHNICAL MANUAL

Wheatstone Corporation
July 2014



Wheatstone Gibraltar Digital Audio Network System

©2014 Wheatstone Corporation

 *Wheatstone Corporation*

600 Industrial Drive

New Bern, North Carolina 28562

tel 252-638-7000 / fax 252-637-1285

Wheatstone GIBALTAR Digital Audio Network System Technical Manual

Table of Contents

Chapter 1 - General Information

Introduction.....	1-3
Wheatstone GIBALTAR NETWORK Router.....	1-4
Gibraltar Router I/O Connections	1-5
The Insulation Displacement Connector System	1-5
Digital Audio Connections.....	1-6
Unbalanced Analog Connections.....	1-6
Unbalanced Digital Connections (SPDIF).....	1-6
WHEATNET Audio Routing Switch Hub	1-7
XY Controller	1-7
Making XY Crosspoints.....	1-8
XY Controller Visibility	1-8
QC Monitor Destination.....	1-8
Metering	1-8
Front Panel LEDs.....	1-8
EXT	1-8
48K or 44.5K Sample Rate.....	1-8
Master/Standby.....	1-8
Error.....	1-9
Internal Programming Options	1-9
Switch Settings	1-9
Jumper Settings	1-9
S-8 WHEATNET Audio Routing Switch Hub.....	1-10
Front Panel LEDs.....	1-10
EXT	1-10
48K or 44.5K Sample Rate.....	1-10
On Line	1-10
Error.....	1-10
Internal Programming Options	1-11
Switch Settings	1-11
Jumper Settings	1-11
WHEATNET I/O Connections	1-12
Audio Network.....	1-12
AES Clock SYNC – “CLK” Connector.....	1-12
Ethernet Interface – “ETH” Connector	1-12
Typical Straight-Through Cable.....	1-13
Typical Crossover Cable.....	1-13
WHEATNET RJ-45 Connections Drawing	1-13

Master Clock for Redundant WHEATNET Systems	1-14
Master Clock Installation	1-14
Preferred Mounting Order	1-14
Cable Pinouts	1-14
Master Clock Operation	1-14
SR-8 Studio Remote Interface	1-15
SR-8 I/O Connections	1-16
MIC/LINE Inputs	1-16
Outputs	1-16
Logic Ports	1-17
Audio Network	1-17
SR-8 I/O Connections Drawing	1-18
Wheatstone Digital Control Surfaces	1-20
Ethernet-Based Controllers	1-21

Chapter 2 - Hardware

Chassis/Backplane Overview	2-6
Chassis Configuration Guidelines	2-7
Audio Slots	2-7
Reserved Slots	2-7
Digital Input Card (AES-2024)	
Overview	2-8
AES Input Interface	2-8
Internal Programming Options	2-8
Status LED's	2-9
Hook-Ups	
DB-25 (for AES-2024/8) - Digital Audio Connections	2-10
2DB-25 (for AES-2024/16) - Digital Audio Connections	2-10
8BNC - Digital Audio Connections	2-12
8RJ-45 - Digital Audio Connections	2-12
DB Panel Pinout Drawing	2-14
2DB Panel Pinout Drawing	2-15
8BNC Panel Pinout Drawing	2-16
8RJ Panel Pinout Drawing	2-17
Analog Input Card (ADI-2001)	
Overview	2-18
Analog Input Interface	2-18
Internal Programming Options	2-18

Status LED's	2-19
Hook-Ups	
Upper DB-25 - Analog Audio Connections	2-20
Lower DB-25 - Analog Audio Connections	2-20
8RJ-45 - Analog Audio Connections.....	2-21
2DB Panel Pinout Drawing	2-22
8RJ Panel Pinout Drawing	2-23
Digital Output Card (DO-2016)	
Overview.....	2-24
AES Output Interface	2-24
AES Channel Status Implementation	2-25
Internal Programming Options.....	2-25
Status LED's	2-26
Hook-Ups	
DB-25 (for DO-2016/8) - Digital Audio Connections	2-27
2DB-25 (for DO-2016/16) - Digital Audio Connections	2-27
8BNC - Digital Audio Connections	2-29
8RJ-45 - Digital Audio Connections.....	2-29
DB Panel Pinout Drawing	2-31
2DB Panel Pinout Drawing	2-32
8BNC Panel Pinout Drawing.....	2-33
8RJ Panel Pinout Drawing.....	2-34
Analog Output Card (AO-2001)	
Overview.....	2-35
Analog Output Interface.....	2-35
Internal Programming Options.....	2-35
Status LED's	2-36
Hook-Ups	
Upper DB-25 - Analog Audio Connections	2-37
Lower DB-25 - Analog Audio Connections	2-37
8RJ-45 - Analog Audio Connections.....	2-38
2DB Panel Pinout Drawing	2-39
8 RJ Panel Pinout Drawing	2-40
Microphone Card (MIC-2001)	
Overview.....	2-41
Analog Input Interface.....	2-41
Internal Programming Options.....	2-41

Status LED's	2-42
Hook-Ups	
Upper DB-25 - Analog Audio Input Connections.....	2-43
Lower DB-25 - Analog Audio Output Connections	2-43
8RJ-45 - Analog Audio Connections.....	2-44
2DB Panel Pinout Drawing	2-45
8RJ Panel Pinout Drawing	2-46
Host CPU (CPU-2001)	
Overview	2-47
Multi CPU/Failover CPU Systems	2-47
CPU-2001 BIOS Settings/Format	2-47
Ethernet IP Addressing	2-48
Ethernet Interface Wiring	2-48
Internal Programming Options	2-48
Switch Settings	2-49
Jumper Settings	2-50
Status LED's	2-51
Hook-Ups	
“IN” and “OUT” BNC - DARS Connections	2-52
RJ-45 - Ethernet Connections	2-52
Typical Straight-Through Cable.....	2-53
Typical Crossover Cable.....	2-53
HCI Panel Pinout Drawing	2-54
Legacy HCI Panel Pinout Drawing	2-54a
Quad Audio Network Card (QAT-2001)	
Overview	2-55
Internal Programming Options	2-57
Switch Settings	2-57
Jumper Settings	2-59
Status LED's	2-60
Hook-Ups	
QCT-2001 - “A”, “B”, “C”, “D” RJ-45 - CAT5/6 Audio Network Connections	2-62
Optical Fiber Interface.....	2-63
QOT-2001	2-63
QFT-2001	2-64

Logic I/O Card (LIO-2001)	
Overview	2-66
Input Ports	2-66
Output Ports	2-67
Typical Input/Output Circuit	2-67
Mic Logic Interface	2-68
Software Programming	2-69
Internal Programming Options	2-69
Jumper/Dipswitch Settings	2-69
Status LED's	2-70
Hook-Ups	2-71
Upper DB-25 - Logic In Ports Connections	2-71
Lower DB-25 - Logic Out Ports Connections	2-71
LRJ-2001 - Logic I/O Connections	2-72
LIO (2DB) Panel Pinout Drawing	2-74
LRJ Panel Pinout Drawing	2-75
Digital Signal Processor Card (DSP-2001)	
Overview	2-76
Internal Programming Options	2-76
Switch Settings	2-77
Jumper Settings	2-77
Status LED's	2-78
Mix Engine Digital Signal Processor Card (DSP-2009)	
Overview	2-79
Internal Programming Options	2-79
Switch Settings	2-80
Jumper Settings	2-80
Status LED's	2-81
Serial Digital Interface Card (SDI-2001)	
Overview	2-82
Format and Standards Compliance	2-82
Physical Interface	2-82
Synchronization	2-82
SDI Card Configuration	2-83
AES Group Selection	2-83
Audio Signal Mapping	2-84

Audio Signal Creation	2-84
Stereo Signal Example	2-84
Surround Signal Example	2-85
Internal Programming Options	2-85
Status LED's	2-86
Hook-Ups	2-87
SDI - Serial Video Connections	2-87

Multichannel Audio Digital Interface Card (MADI-2001)

Overview	2-88
Format and Standards Compliance	2-88
Physical Interface	2-88
Synchronization	2-89
MADI Card Configuration	2-89
Audio Signal Mapping	2-90
Audio Signal Creation	2-90
Mono Signal Example	2-90
Stereo Signal Example	2-91
Internal Programming Options	2-91
Status LED's	2-92
Hook-Ups	2-93
Digital Audio Connections	2-93
Optical Fiber Interface	2-93

Chapter 3 - Controller Devices

XP Configuration GUI	3-2
PC_XYC - Optional Controller Software	3-3
Ethernet-Based Controllers	3-5

Chapter 4 - XPoint Software Setup Guide

GIBALTAR Ethernet/IP Address Quick Start	4-3
Ethernet Cabling	4-3
Default IP Address	4-3
Changing your PC's IP Address	4-3
Changing the GIBALTAR's IP Address	4-4
Configuring IP Address in XPoint Software	4-4
Saving the GIBALTAR Configuration	4-4
Getting Started	4-5

GUI Log-In	4-5
Passwords	4-5
Connection Between the Configuration GUI and Master Rack .	4-6
System Configuration Menus	4-9
Tier Configuration	4-9
Control Surface Configuration	4-10
Rack Configuration	4-11
Adding a Card to a Rack	4-12
Card/Signal Definition	4-12
Audio/Mixer/Quad Network Card Definition	4-12
CPU Card Definition	4-12
LIO Card Definition	4-12
Mic and Variable Line Gain Card Definition	4-12
Analog Card Definition	4-14
Digital Card Definition	4-15
Viewing Defined Source & Destination Signals	4-16
Configuration Rules	4-16
Completing the Configuration	4-17
Saving Your Configuration	4-17
Config.txt File	4-17
Signal Definition	4-20
Alias Signals	4-21
Configuring Logic I/O	4-23
Overview	4-23
Routable Logic	4-23
Triggered Port Logic	4-23
Routable Logic Signal Definitions	4-24
Defining Routable Logic Functions	4-25
Viewing Defined Logic Signals	4-25
Configuring Triggered Port Logic	4-26
Signal Locking	4-27
Salvo Definition	4-27
Control Surface Configuration	4-29
Surface Visibility Settings	4-29
VDip Settings	4-30
Line Gain	4-31
Microphone Gain	4-31
Mix Minus Polarity	4-31
Password Modes	4-32
Programmable Buttons	4-32
Special Functions - Console Locks	4-33
Console Presets	4-33
Tool Bars	4-35
Main Menu Summary	4-37
File Menu	4-37
User Menu	4-37
Configure Menu	4-37
View Menu	4-38

Help Menu	4-38
Diagnostics Menu.....	4-38
Diagnostics Menu Examples	4-39
Setting Up an Air Tally with the GIBALTAR Router System.....	4-40
Step 1 - Create a Logic Destination in the XPoint Matrix.....	4-40
Step 2 - Modify the VDip settings	4-41
Step 3 - Wire Up the Logic Port	4-41
Step 4 - Create a New Crosspoint	4-41

Glossary

Terminology	G-1
-------------------	-----

Appendices

Appendix 1

Configuring System IP Addresses.....	A-3
--------------------------------------	-----

Appendix 2

Failover CPU Configuration and Operation	A-7
--	-----

Appendix 3

Replacement Parts List.....	A-10
-----------------------------	------

General Information

Chapter Contents

Introduction.....	1-3
Wheatstone GIBALTAR NETWORK Router.....	1-4
Gibraltar Router I/O Connections	1-5
The Insulation Displacement Connector System	1-5
Digital Audio Connections.....	1-6
Unbalanced Analog Connections.....	1-6
Unbalanced Digital Connections (SPDIF).....	1-6
WHEATNET Audio Routing Switch Hub	1-7
XY Controller	1-7
Making XY Crosspoints.....	1-8
XY Controller Visibility	1-8
QC Monitor Destination.....	1-8
Metering	1-8
Front Panel LEDs.....	1-8
EXT	1-8
48K or 44.5K Sample Rate.....	1-8
Master/Standby.....	1-8
Error.....	1-9
Internal Programming Options	1-9
Switch Settings	1-9
Jumper Settings	1-9
S-8 WHEATNET Audio Routing Switch Hub.....	1-10
Front Panel LEDs.....	1-10
EXT	1-10
48K or 44.5K Sample Rate.....	1-10
On Line	1-10
Error.....	1-10
Internal Programming Options	1-11
Switch Settings	1-11
Jumper Settings	1-11
WHEATNET I/O Connections	1-12
Audio Network.....	1-12
AES Clock SYNC – “CLK” Connector.....	1-12
Ethernet Interface – “ETH” Connector	1-12
Typical Straight-Through Cable.....	1-13
Typical Crossover Cable.....	1-13
WHEATNET RJ-45 Connections Drawing	1-13

Master Clock for Redundant WHEATNET Systems 1-14

- Master Clock Installation 1-14
- Preferred Mounting Order 1-14
- Cable Pinouts 1-14
- Master Clock Operation 1-14

SR-8 Studio Remote Interface 1-15

- SR-8 I/O Connections 1-16
 - MIC/LINE Inputs 1-16
 - Outputs 1-16
 - Logic Ports 1-17
 - Audio Network 1-17
 - SR-8 I/O Connections Drawing 1-18

Wheatstone Digital Control Surfaces 1-20

Ethernet-Based Controllers 1-21

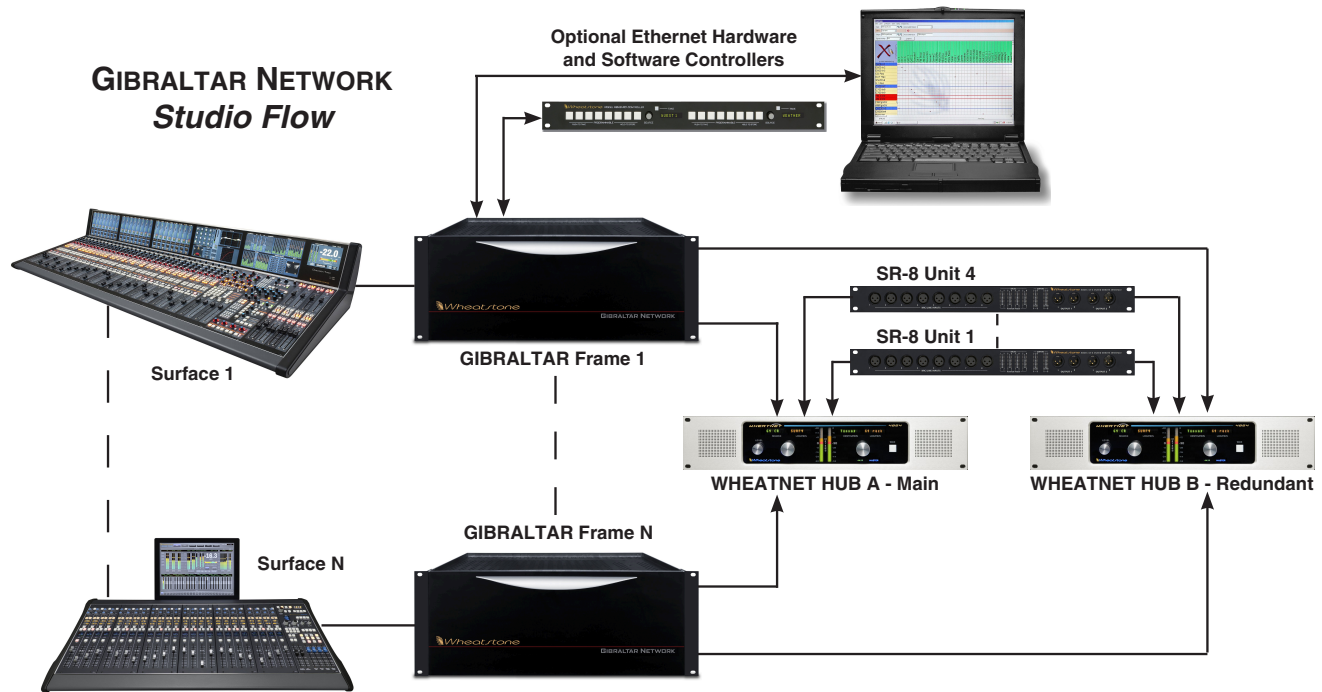

General Information

Introduction

The Wheatstone GIBALTAR network system is an audio routing and control system comprised of a number of components that are interconnected via CAT-5 or fiberoptic links. System components include GIBALTAR NETWORK router cages, SR-8 Studio Remote Interface units, various versions of X, Y, and XY Controllers, WHEATNET Central Switch Hub, and Wheatstone control surfaces.

Start your system with a simple AES router with analog and/or digital inputs and outputs. From there you can add logic I/O cards and scheduling software to interface to your automation system. You can add mix engine (DSP) cards to provide signal mixing, EQ, dynamics, and other functions. You can link multiple master GIBALTAR NETWORK cages together to achieve thousands and thousands of I/O ports. Cages can be separated by very long distances with many studios connected to your central rack room, providing shared resources, yet still permitting independently functioning satellite studios, each with its own combination of analog and digital input and output cards and connector modules specifically selected to suit a large variety of gear. Individual GIBALTAR NETWORK units may be connected together to form a “Multi-Tiered” switch, arranged in a star topology, with a central Hub router connected to multiple routers. You can choose from an entire family of Wheatstone digital control surfaces specialized for production room, on-air, or voicetrack applications. We also provide a full complement of Ethernet protocol remote router control panels, as well as a complete family of plug-in modules that interface the routing system to existing Wheatstone digital and analog stand-alone consoles.

With up to 48 rear mounted CAT-5 ports of the Wheatstone WHEATNET Audio Routing Switch Hub, you stand ready for the largest multiple studio systems. You can choose from four variations of the WHEATNET units to suit your studio systems: WHEATNET 4864 rack unit with 48 ports, 3264 with 32 ports, 2464 with 24 ports, or 1664 with 16 ports. If redundancy is required, just add a second WHEATNET unit with duplicate lines to your remote cages.

Wheatstone GIBALTAR Network Router

The GIBALTAR NETWORK rackmount unit occupies four 19" wide rack spaces (total height 7"), the chassis of the unit has a width of 17-5/32". The unit has a depth of 16-47/64" behind the rack rails. To open a front cover and get access to I/O cards the space of 12-1/2" is needed in front of the rack rails. An additional five inches of space behind the chassis is required for wiring cables to pass through.

The GIBALTAR NETWORK is a unit that can take up to 512 discrete analog and digital (AES format) audio inputs and switch them to any of 512 separate outputs. The unit's backplane carries these signals via 32 16xTDM busses. Various input sources place the signals onto the TDM busses, while output cards can select any combination of signals to take off the TDMs to drive their output channels.

The GIBALTAR NETWORK cage has sixteen slots for I/O cards (route, mix, logic, CPU and network), plus a plug-in power supply module (a second redundant power supply module is optional). DSP/CPU failover is also available.

IMPORTANT: There should be 1RU of space both above and below the GIBALTAR NETWORK cage. Please use the provided 1RU vented spacers.



All audio input and output signal, serial control, audio network, and ethernet connections are made via various I/O connector modules that plug into the rear of the chassis. You can choose from a family of I/O panels to match your equipment or interface requirements. Pick from 110 ohm balanced DB connectors or 110 ohm CAT-5 connectors. There is also a 75 ohm BNC option – a real plus for compatibility in television facilities. Cage-to-cage network connections can be made by CAT-5 or optical fiber links.

For detailed description and pinout information of I/O cards refer to Chapter 2 - *Hardware*.

Energize the cage by plugging it into the AC mains.

Power up Sequence – When first powering the system it is best to apply power to the WHEATNET first, then GIBALTAR racks, and finally the surface. You may cycle power on surfaces or Gibraltar as required after the WHEATNET is up and running.

GIBRALTAR ROUTER I/O Connections

Various I/O connector modules plug right into the GIBRALTAR rear to give you a choice of DB-25 or RJ-45 connections for analog or digital audio interface, or BNC connectors for use with 75 ohm digital audio equipment. RJ-45 connectors are also available for use with CAT-5 wiring systems. The DB-9 connectors are used for connections to the serial interface. Refer to Chapter 2 *Hardware* for connection details,

The Insulation Displacement Connector System

The DB-25 and DB-9 I/O wiring interface system is based on insulation displacement technology. A special AMP wiring tool is included with each system; it is auto-indexing, and allows individual wire connections to be positively made with a single squeeze of the tool's trigger. The trigger action is ratchet controlled, and will not release until a full connection is made. Once released, the multipin connector held in the tool's jaw automatically indexes to the next connector pin. The technology is such that no stripping, soldering or tinning of wire ends is required; all that is needed is for the wires destined for the connector be snub cut and laid out in order (although tubing should be used on bare drain wires). An empty DB-25 or

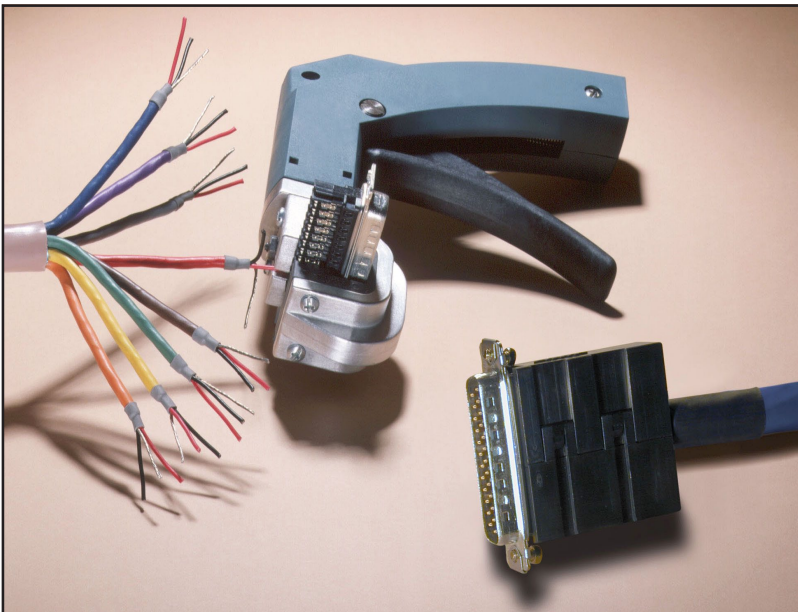

The AMP tool insulation displacement connector system. Note the straight hood with self-locking tabs. The tool, multipin connectors (with gold plated pins) and latching hoods are supplied with the Router.

DB-9 connector is inserted into the tool, indexed to the first pin, and the wires are inserted one by one into the jaw and the trigger squeezed. In this way a single multipin connector can be completely wired up in a minute or two.

In the event of a wiring error, connector pins may easily be removed from the shell with the wire still attached, and inserted into the correct position. Observe the side of the connector, with the metal part down. You will see a row of “Vees”—simply press the top of the vee together with a scribe or other sharp instrument; this will unlock the pin from the shell, and it can be removed and inserted into the correct position. Spread the vee apart to lock the pin in the new position. It should never be necessary to discard a connector due to a wiring error.

Note that mating hoods for each connector are also supplied with the console. These have locking screws that hold the connectors securely to the rear of the router mainframe.

Digital Audio Connections

CABLE – All AES/EBU input and output digital audio connections are balanced and should be made using a high quality digital audio cable. Be sure to select a digital audio cable with an integral drain wire of the same wire gauge (AWG) as the twisted pair as this facilitates an easier consistent termination process. Typical AES/EBU digital audio cable has a very low characteristic capacitance per ft (pF/ft), and a nominal impedance of 110Ω. High quality digital audio cable offers better signal transmission performance versus typical analog audio cable, especially over long cable runs. Check the cable manufacturer’s data sheet to be sure the cable you plan to use will work in your application.

CONNECTORS – Typically, all AES/EBU connections are made with the supplied DB-25 male mating connectors. These crimp style connectors are the insulation displacement type and will accept wire gauge 22 – 26AWG. If an optional rear panel connector type (e.g. BNC, RJ-45, etc.) was specified and shipped with your system, please refer to the mating connector manufacturer’s recommendations for termination instructions.

Unbalanced Analog Connections

ANALOG INPUTS – Wire to the router input end with typical shielded, two conductor cable (like Belden 9451), just as if you were connecting a balanced source. At the unbalanced source machine’s output, connect the + output to the HI input wire and connect the source machine GND wire to LO, connect the shield at one end only.

Note: Unbalanced analog sources typically have -10dBv (316mV RMS) signal levels and will not match the GIBALTAR nominal operating level of +4dBu (1.23V RMS). We highly recommended that you first externally balance any unbalanced sources you plan on connecting to the GIBALTAR. Many third party “match boxes” are commercially available for this.

ANALOG OUTPUTS – Use a balanced output circuit which behaves exactly like the secondary of a high-quality transformer, with no center tap—this output is both balanced and floating. For unbalanced operation, either the HI *or* LO side of the analog output must be strapped to ground of the unbalanced input, with the output taken from the other side. (Normally you would strap LO to ground, and use HI to feed your unbalanced equipment input.) Leave the SH floating at one end.

Unbalanced Digital Connections (SPDIF)

SPDIF INPUTS – The SPDIF (Sony/Phillips Digital Interface) or “consumer” digital audio interface is a two wire unbalanced signal typically on a single RCA style connector. Note that the SPDIF signal level of approximately 500mV and 75 ohm impedance does not correctly match the Router AES inputs. We highly recommend using a “balun” or format converter when interfacing “consumer” grade source devices to the GIBALTAR.

In cases where a consumer grade device must be interfaced and the appropriate matching device is not available, try wiring the SPDIF center conductor (HOT) to the HI input pin and SPDIF shell (ground) to the LO input. Connect SH at the GIBALTAR end only.

SPDIF OUTPUTS – The GIBALTAR digital outputs are fixed, professional, AES-3 formatted outputs. SPDIF consumer format is not supported. Use an external format converter to connect the digital outputs to consumer gear.

WHEATNET Audio Routing Switch Hub



WHEATNET is the most advanced central switch available to integrate with other Wheatstone GIBRALTAR NETWORK and control surface components. WHEATNET is capable of simultaneously switching 64 bi-directional audio channels to each of 48 ports – that’s 6144 traffic channels. You can choose from four variations of the WHEATNET units to suit your studio systems: WHEATNET 4864 rack unit with 48 ports, 3264 with 32 ports, 2464 with 24 ports, or 1664 with 16 ports.

WHEATNET occupies two 19" wide rack units (total height 3-1/2") of vertical space, the chassis of the unit has a width of 17-3/8". This unit has a depth of 13" behind the rack rails. Space needed in front of rack rails is 3/4". An additional five inches of space behind the chassis is required for wiring cables to pass through.

The built in QC station provides the ability to instantly select, monitor, and meter any source in the system. The X-Y controller provides full source/destination control. A special monitor destination routes any source to the built-in stereo speakers with level control for system-wide monitoring functions. The front panel stereo meter automatically displays the signal level of the selected monitor source. LED indicators on the right-lower part of the front panel display system status, sample rate and external clock functions. XPoint software enables remote monitoring and control of the WHEATNET source and destination signal space over Ethernet.

With forty-eight rear mounted CAT-5 ports, you stand ready for the largest multiple studio systems. If redundancy is required, just add a second WHEATNET with duplicate lines to your remote cages. This provides failover redundancy for the entire network system.

Installation is simple: run one CAT-5 wire to the WHEATNET from each of your studios (or I/O locations), and a second CAT-5 from each WHEATNET, GIBRALTAR, and surface to a central network hub or switch.

Assuming the WHEATNET is correctly rackmounted, you may now energize it by connecting the factory supplied power cord to the rackmount unit and then plugging it into the AC mains.

Note: To de-energize the WHEATNET, unplug its AC cord from the AC mains.

XY Controller

This section provides a means of routing input Sources to output Destinations. Sources may be any physical audio input wired to a GIBRALTAR rack or any control surface mix (PGM bus, AUD bus, Mix-Minus, etc.). Destinations may be any physical device wired to a GIBRALTAR rack output or any Wheatstone control surface input (faders, Studio or CR external inputs, talkback bus, etc.).

Making XY Crosspoints

Use the following procedure to route a Source signal to a Destination signal.

- Rotate the DESTINATION knob until the desired destination is shown in the DESTINATION/LOCATION displays.
- Rotate the SOURCE knob until the desired source is displayed in the SOURCE/LOCATION displays.
- Press the TAKE button.

XY Controller Visibility

Wheatnet's built in XY Controller is configured to "see" all of the source and destination signals in a system.

QC Monitor Destination

There is a special MONITOR destination that allows the user to meter and listen to any source on the router.

Choose Monitor by dobbing the LEVEL knob; "MONITOR"/"WHEATNET" will appear in the DESTINATION/LOCATION displays. The operator selects the desired monitor source by rotating the SOURCE knob. When the desired monitor source is shown in the SOURCE display, pressing the TAKE button will route the selected Source to the special Monitor Destination. The front panel meter will display the selected Source's signal level and rotating the LEVEL knob controls the built-in monitor speakers level.

TIP:
DOBBY (pronounce dah-bee) - means to quickly press and release an encoder knob.

Metering

The front panel meter allows you to monitor the signal level of any source routed to the Monitor destination. The meter displays both the peak and average digital domain signal level of the selected source. This meter uses the Full-Scale-Digital (dBFS) scale. OdBFs is equal to +24dBu in analog. The WHEATNET system 0VU reference level is:

-20dBFS digital = +4dBu (1.23VRMS) analog.

Front Panel LEDs

On the right-lower part of the front panel there are six LEDs. Following is the description of the status of those LEDs.

EXT

The "EXT" LED lights up when an external AES reference clock is connected to the WHEATNET and SW2 pos.3 on the IB-1PCB is OFF.

The "EXT" LED will flash showing AES SYNC warning if the external AES sync is lost when SW2 pos.3 is ON.

48K or 44.1K Sample Rate

Indicates the internally selected system sample rate, "48K" or "44.1K."

Master/Standby

If the network system has two WHEATNETs connected together, then the "MASTER" LED will light up on the primary unit and the "STANDBY" LED will light



All devices in the system must be set to the same sample rate!

up on the secondary unit. In a fail over state, the secondary WHEATNET's MASTER LED will light.

Error

In the unlikely event of a WHEATNET CPU failure the "ERROR" LED will light up.

Internal Programming Options

All internal programming options are made via IB-1PCB mounted dipswitches and jumpers.

Switch Settings

SW1, SW3 - CPU Reset

These momentary pushbutton switches allow the CPU to be reset without powering down the system. Holding either button for two seconds will also cause the FPGA program to be reloaded, first breaking all audio crosspoints. Upon re-boot completion, the CPU will remake all system crosspoints.

The recessed SW1 is accessible from the rear and is located next to the ETHERNET port. SW3 is accessible on the main motherboard.

DIPSW2

Pos.1 - 48/44.1 Sample Rate - Off = 44.1k, On = 48k

Pos.2 - Reserved - Never ON

Pos.3 - External AES SYNC Warning - When On, causes "EXT" LED on front panel to flash whenever external AES SYNC is lost. Should be ON for HUB A (primary) if external AES SYNC is used. Should always be On for HUB B (redundant).

Pos.4 - PRI/SEC select - OFF = Primary, ON = Redundant

Jumper Settings

J1 - CPU I/O PGRM - Momentary shorting will reload the CPU FPGA program.

J2 - PBRST - Factory Use Only

J3 - Not Used

S-8 WHEATNET Audio Routing Switch Hub



S-8 WHEATNET is the high speed central network switch that connects up to eight studios from the technical operations center. S-8 WHEATNET is capable of simultaneously switching 64 bi-directional audio channels to 8 ports – that’s 1024 traffic channels.

S-8 WHEATNET occupies one 19" wide rack space and requires one rack unit (1-3/4") of vertical space, the chassis of the unit has a width of 15-1/2". This unit has a depth of 13" behind the rack rails. An additional five inches of space behind the chassis is required for wiring cables to pass through.

Front panel LED indicators display system status, sample rate, and external clock functions. No external PC is required for continuous operation.

The eight rear mounted RJ-45 audio network ports easily integrate multiple studio systems. Installation is simple: run one UTP CAT-5 crossover cable to the S-8 WHEATNET from each of your studios or locally mounted I/O centers.

Another wiring option is to run a UTP CAT-5 straight connection from the rack room to a small RJ-45 patch point block in each studio. The final connection to each GIBRALTAR NETWORK rack or control surface can then be made using an off the shelf crossover patch cable.



CAT-5 Wiring Tip

Front Panel LEDs

On the right-lower part of the front panel there are five LEDs, that function as follows.

EXT

The “EXT” LED lights up when an external AES reference clock source is connected to the S-8 WHEATNET.

48K or 44.1K Sample Rate

Indicates the internally selected system sample rate, “48K” or “44.1K”.

Note that all S-8 WHEATNET devices must operate at the same sample rate. Please consult the factory before changing sample rate.



All devices in the system must be set to the same sample rate!

On Line

The “ON LINE” LED lights when the WHEATNET S-8 CPU has booted and is ready for use.

Error

In the unlikely event of a S-8 WHEATNET CPU failure the “ERROR” LED will light up.

Internal Programming Options

All internal programming options are made via PCB mounted dipswitches and jumpers.

Switch Settings

SW1 - CPU Reset

This momentary pushbutton switch allows the CPU to be reset without powering down the system. Holding the button for two seconds will also cause the FPGA program to be reloaded, first breaking all audio crosspoints. Upon re-boot completion, the CPU will remake all system crosspoints.

The recessed SW1 is accessible from the rear and is located next to the ETHERNET port.

DIPSW3

Pos.1 (labeled DIPSWØ on the circuit board) - 48/44.1 Sample Rate
Off = 44.1K, On = 48K

Pos.2 - reserved - never ON

Pos.3 - reserved - never ON

Pos.4 - PRI/SEC select - OFF = Primary, ON = Redundant (not used)



All devices in the system must be set to the same sample rate!

Jumper Settings

J1 - CPU I/O PGRM

Momentary shorting will reload the CPU FPGA program.

J2 - PBRST

Factory Use Only

WHEATNET I/O Connections

All audio network, master clock, and Ethernet connections are made via RJ-45 connectors mounted on the WHEATNET rear panel. The pinout drawings on page 1-18 summarize all wiring connections.

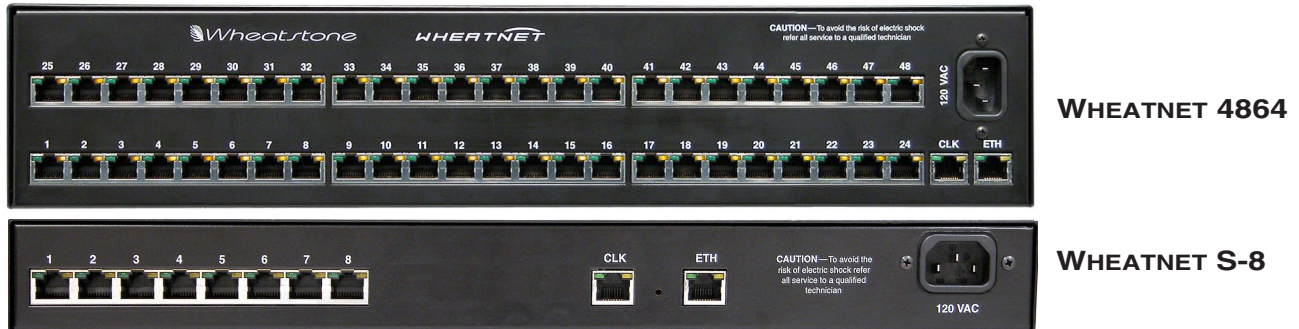

Audio Network

QAT cards installed in GIBRALTAR racks are connected to WHEATNET via crossover CAT-5 cables. For typical CAT-5 cable pinouts see page 1-16.

- Pin 1 – TX +
- Pin 2 – TX -
- Pin 3 – RX +
- Pin 6 – RX -

AES Clock Sync – “CLK” Connector

The WHEATNET Network system’s sample rate is normally derived from its own internal crystal oscillator. The AES Clock sync connector provides a means for synchronizing the Network system to an external AES-11 DARS master clock signal at 44.1 or 48kHz.

To sync your WHEATNET to an external AES Black clock source use the AES Sync IN port available on the “CLK” RJ-45 connector:

- Pin 1 – AES SYNC OUT HI
- Pin 2 – AES SYNC OUT LO
- Pin 3 – AES SYNC IN HI
- Pin 6 – AES SYNC IN LO

Valid sample rates are 44.1kHz and 48kHz. EXT sync must match the internal crystal setting. When sync is detected the front panel EXT LED will light. Use only a high grade Digital Audio Reference Signal (DARS) per AES-11 specification.

Ethernet Interface – “ETH” Connector

Connect WHEATNET to your Ethernet LAN via straight (pin to pin) CAT-5 cable. The LAN connection is for communicating with computers running Wheatstone software such as XPoint, PC-XYC, and Event Computer. If you are connecting directly between the computer and the WHEATNET with no network in between, use a crossover cable. For typical and crossover CAT-5 cable pinouts see below.

- Pin 1 – TXD +
- Pin 2 – TXD -
- Pin 3 – RXD +
- Pin 6 – RXD -

Typical Straight-Through Cable

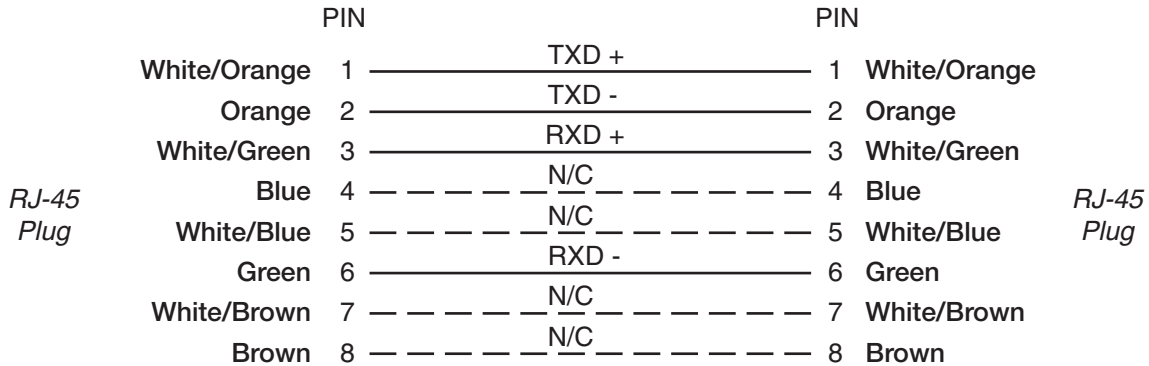

Typical Crossover Cable

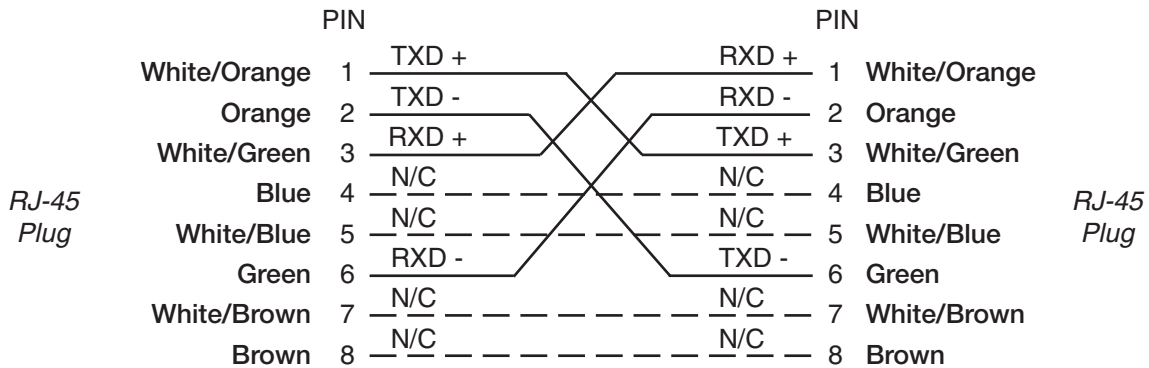

WHEATNET RJ-45 Connections

AUDIO NETWORK

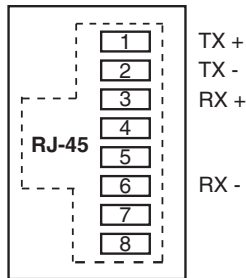

AES CLOCK SYNC "CLK"

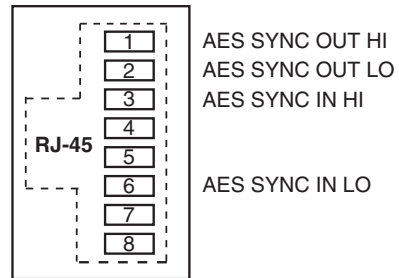

ETHERNET "ETH"

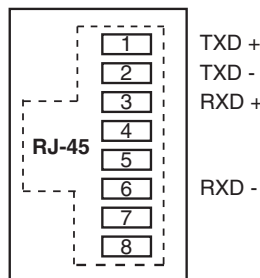

Master Clock for Redundant WHEATNET Systems

Bridge systems which include redundant WHEATNET interfaces require a crossover connection between the two WHEATNET master clock inputs for seamless automatic failover. Optionally you can use an external AES-11 master clock to feed both WHEATNET units.

Master Clock Installation

The external masters DARS reference must provide two physical outputs. Simply connect one clock output of the master clock to the CLK connector on the primary WHEATNET, and a second output of the master clock to the CLK connector on the secondary WHEATNET. Use a balun to connect 75 Ohm DARS on coax to a suitable XLR to RJ-45 connection.

Preferred Mounting Order

Total number of required rack spaces is 7 RU (12-1/4") for WHEATNET or 5 RU (8-3/4") for S-8 E-WHEATNET plus any space required for the optional master clock. Devices are listed in order, top to bottom.

Optional Master clock

1 RU Blank rack space

2 RU WHEATNET #1 or 1 RU for S-8 WHEATNET #1

1 RU Blank rack space

2 RU WHEATNET #2 or 1 RU for S-8 WHEATNET #2

1 RU Blank rack space

Cable Pinouts

The interconnect cable is made with CAT-5 UTP cable. RJ-45 Pins 3 and 6 must use a twisted pair.

WHEATNET CLK RJ-45

Pin 3 – AES SYNC IN HI

Pin 6 – AES SYNC IN LO

Pin 1 – AES SYNC OUT HI

Pin 2 – AES SYNC OUT LO

Master Clock Operation

The optional master clock used with your system must be set to the sample rate of your overall system (44.1 kHz or 48 kHz) and **CANNOT** be changed without updating certain dipswitch settings in various Wheatstone devices.

Please refer to the optional master clock's manual for detailed operation.

SR-8 Studio Remote Interface



The SR-8 rackmount unit occupies one 19" wide rack space and requires one rack unit (1-3/4") of vertical space. The chassis of the unit has a width of 17-7/16". The SR-8 unit has a depth of 12-1/16" behind the rack rails (including chassis connectors). An additional five inches of space in front of rack and behind the chassis is required for wiring cables to pass through.

The SR-8's front panel houses INPUTS and OUTPUTS meters and PHANTOM POWER, AT LINK, and DC PWR status indicators.

The front panel also has eight female XLR connectors for microphone/line inputs and four male XLR connectors for two stereo, four mono, or combination of one stereo and two mono analog outputs.

Phantom power can be applied independently to each of the individual inputs.

Two DB-9 connectors on the rear panel of the SR-8 provide 12 logic ports, which can be individually designated during set up as inputs or outputs. Use these ports to wire the various external switches, indicators, and control functions you need in your facility.

There are five RJ-45 and OPTO connectors for CAT-5 or Fiber connections to your system. Connect the AT LINK A-B to a port on the Wheatstone Hub, or to a port on a Wheatstone QAT card in a rack, according to how the system has been preconfigured. The LINK 1-3 connections are used to connect up to three additional SR-8 units to expand the I/O capability in the studio. Refer to your system's connection map or XPoint to determine where the various ports should connect.

The unit has two standard IEC power connectors. The SR-8 has an internal power supply that will accept 100-240 volts 50/60 hertz AC power.

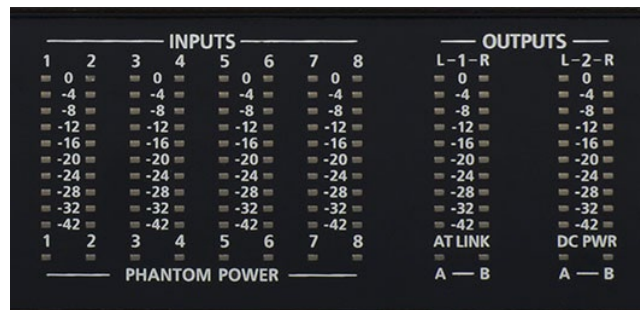

SR-8 I/O Connections

All audio input and output, control, Ethernet, and power supply connections are made via XLR, DB-9, RJ-45, and OPTO connectors mounted on the SR-8 front and rear panel. The pinout drawings on pages 1-18 and 1-19 summarize all wiring connections.

MIC/LINE Inputs

The SR-8 analog mono mic level input (-50dBu nominal) is fed from the female XLR connector to the internal microphone preamplifier. The mic preamp has digitally controlled gain, up to a maximum of 70 dB, and displays remarkably high performance and accuracy. Phantom power is available.

XLR#1 Pin 1 – SH	}	Mic/Line 1 In
XLR#1 Pin 2 – HI		
XLR#1 Pin 3 – LO		
XLR#2 Pin 1 – SH	}	Mic/Line 2 In
XLR#2 Pin 2 – HI		
XLR#2 Pin 3 – LO		
XLR#3 Pin 1 – SH	}	Mic/Line 3 In
XLR#3 Pin 2 – HI		
XLR#3 Pin 3 – LO		
XLR#4 Pin 1 – SH	}	Mic/Line 4 In
XLR#4 Pin 2 – HI		
XLR#4 Pin 3 – LO		
XLR#5 Pin 1 – SH	}	Mic/Line 5 In
XLR#5 Pin 2 – HI		
XLR#5 Pin 3 – LO		
XLR#6 Pin 1 – SH	}	Mic/Line 6 In
XLR#6 Pin 2 – HI		
XLR#6 Pin 3 – LO		
XLR#7 Pin 1 – SH	}	Mic/Line 7 In
XLR#7 Pin 2 – HI		
XLR#7 Pin 3 – LO		
XLR#8 Pin 1 – SH	}	Mic/Line 8 In
XLR#8 Pin 2 – HI		
XLR#8 Pin 3 – LO		

Outputs

The output signals are available as analog line level (+4dBu, balanced) on the four XLR connectors.

XLR#1 Pin 1 – SH	}	Output 1 Lt Out
XLR#1 Pin 2 – HI		
XLR#1 Pin 3 – LO		
XLR#2 Pin 1 – SH	}	Output 1 Rt Out
XLR#2 Pin 2 – HI		
XLR#2 Pin 3 – LO		

XLR#3 Pin 1 – SH	}	Output 2 Lt Out
XLR#3 Pin 2 – HI		
XLR#3 Pin 3 – LO		
XLR#4 Pin 1 – SH	}	Output 2 Rt Out
XLR#4 Pin 2 – HI		
XLR#4 Pin 3 – LO		

Logic Ports

Two DB-9 LOGIC I/O connectors provide 12 Universal logic ports.

1-6 DB-9

- Pin 1 – +5V Digital
- Pin 2 – Logic 1 In/Out
- Pin 3 – Logic 2 In/Out
- Pin 4 – Logic 3 In/Out
- Pin 5 – Logic 4 In/Out
- Pin 6 – Logic 5 In/Out
- Pin 7 – Logic 6 In/Out
- Pin 8 – Not Used
- Pin 9 – Logic Digital Ground

7-12 DB-9

- Pin 1 – +5V Digital
- Pin 2 – Logic 7 In/Out
- Pin 3 – Logic 8 In/Out
- Pin 4 – Logic 9 In/Out
- Pin 5 – Logic 10 In/Out
- Pin 6 – Logic 11 In/Out
- Pin 7 – Logic 12 In/Out
- Pin 8 – Not Used
- Pin 9 – Logic Digital Ground

Audio Network

SR-8 unit connects to your network via crossover CAT-5 cables. For typical CAT-5 cable pinouts see page 1-13.

- Pin 1 – TXD +
- Pin 2 – TXD -
- Pin 3 – RXD +
- Pin 6 – RXD -

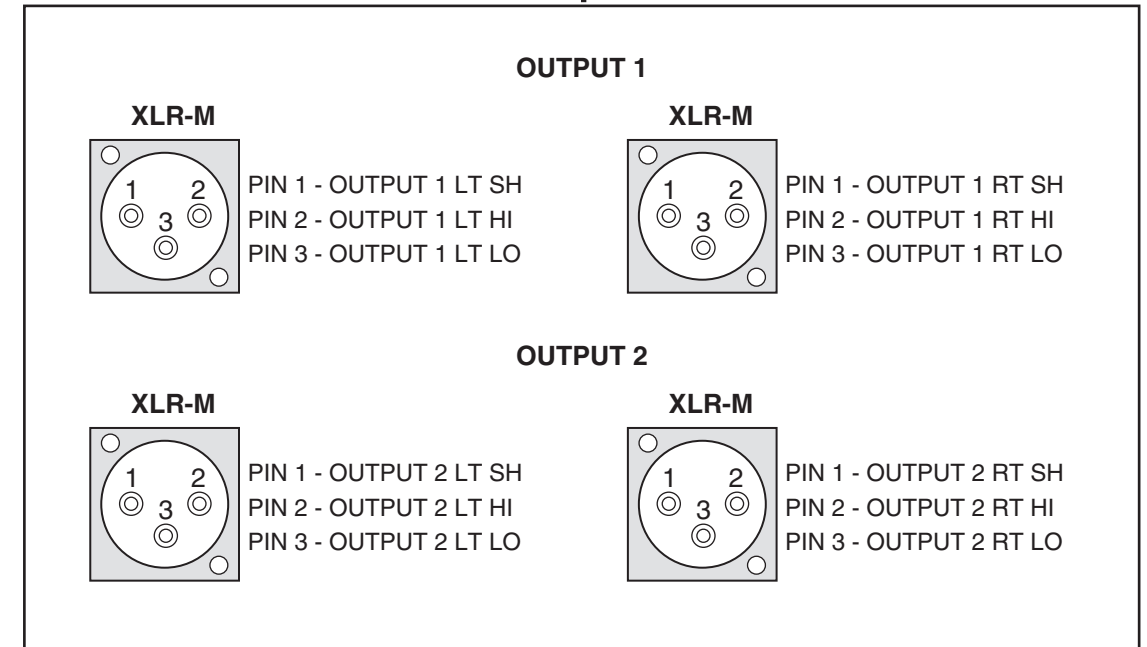
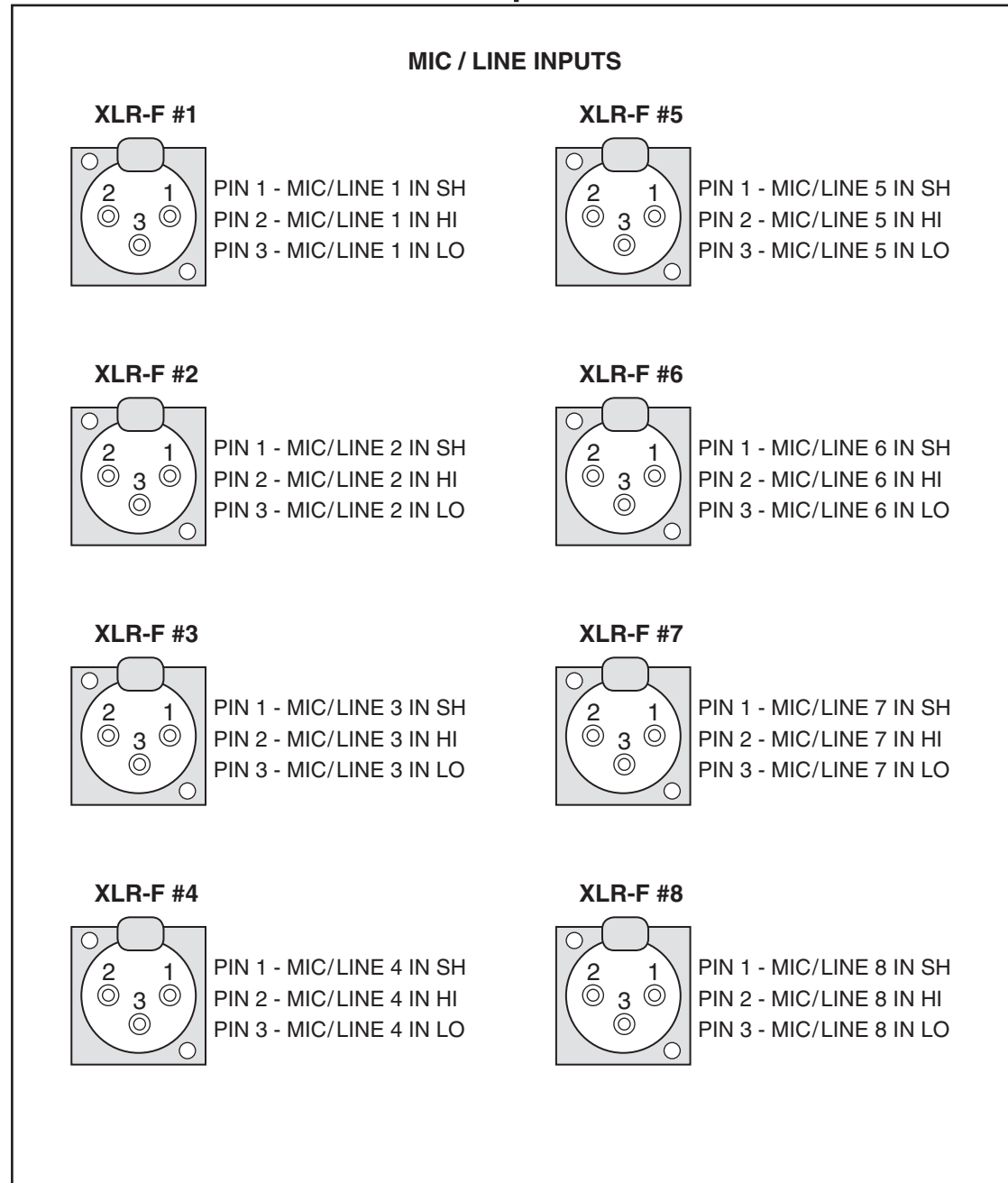

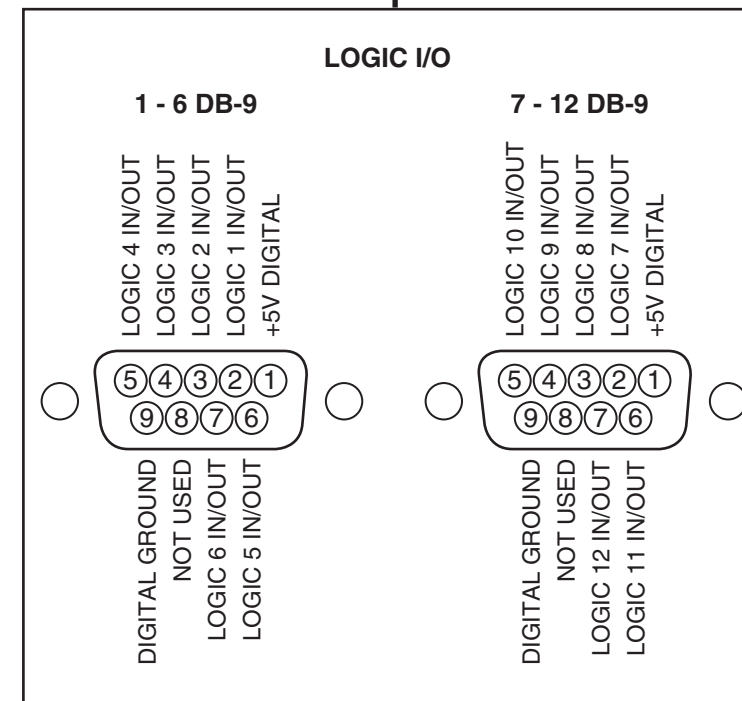
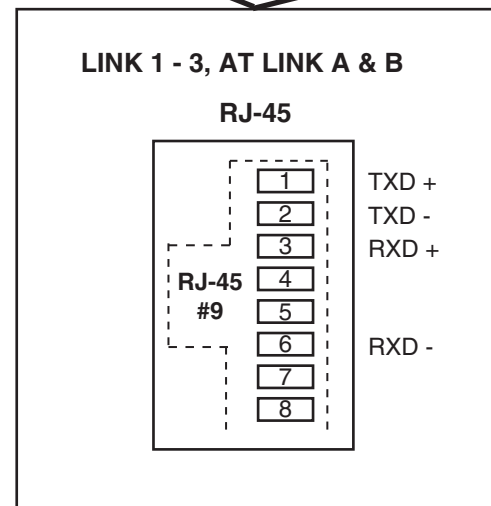
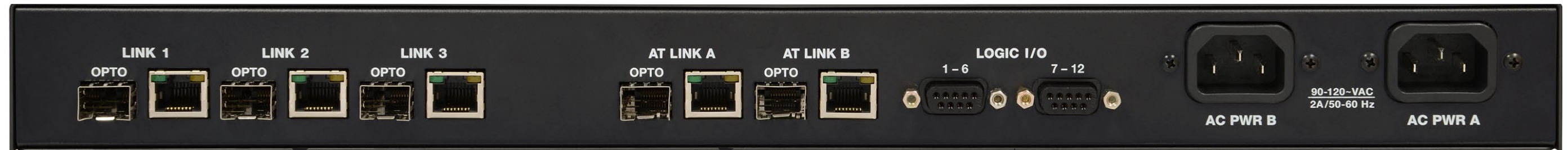

Wheatstone Digital Control Surfaces



Designed to integrate flawlessly with the Wheatstone GIBRALTAR NETWORK digital audio router, the Wheatstone digital control surfaces allow you to easily create large- or small- platform-based systems that are exceptionally user-friendly and flexible. They will handle your most demanding requirements, and be able to change with your varying needs as they arise. You can select any combination of input signals in the entire GIBRALTAR NETWORK system and create a multitude of mixes from them. Onboard routing control allows all these mixes to be directed to any destination in your facility. Powerful built-in equalization and gain reduction circuits let you tame and sweeten any signal you come across. An RJ-45 Audio Transport “MIXER” connector on the rear of the control surface serves as the link between the surface and the network system. Operation of the control surfaces is covered in the specified separate Technical Manual.

Ethernet-Based Controllers

A family of Ethernet-based controllers provides an integrated way of switching Digital Audio Router sources to destinations connected to the console. Rackmount and modular versions of the Ethernet based controllers are available. Mount the Ethernet based controller modules into existing Audioarts's stand-alone analog or digital mixing consoles. Choose from eight or sixteen button source selectors, dual source select panels, or single and dual X-Y panels.



A/D SERIES MODULE
Hot Button x 16
HBX16-8

A/D SERIES MODULE
Hot Button x 8
HBX8-8

A/D SERIES MODULE
Dual Hot Button x 8
HBX8-8D

A/D SERIES MODULE
LCD Switch x 12
LCX12-8

A/D SERIES MODULE
LCD Switch x 8
LCX8-8

A/D SERIES MODULE
XY Controller
XYE-8

A/D SERIES MODULE
Dual XY Controller
XYE-8D

AUDIOARTS MODULE
Hot Button x 8
HBX8-55/90

GENERAL INFORMATION

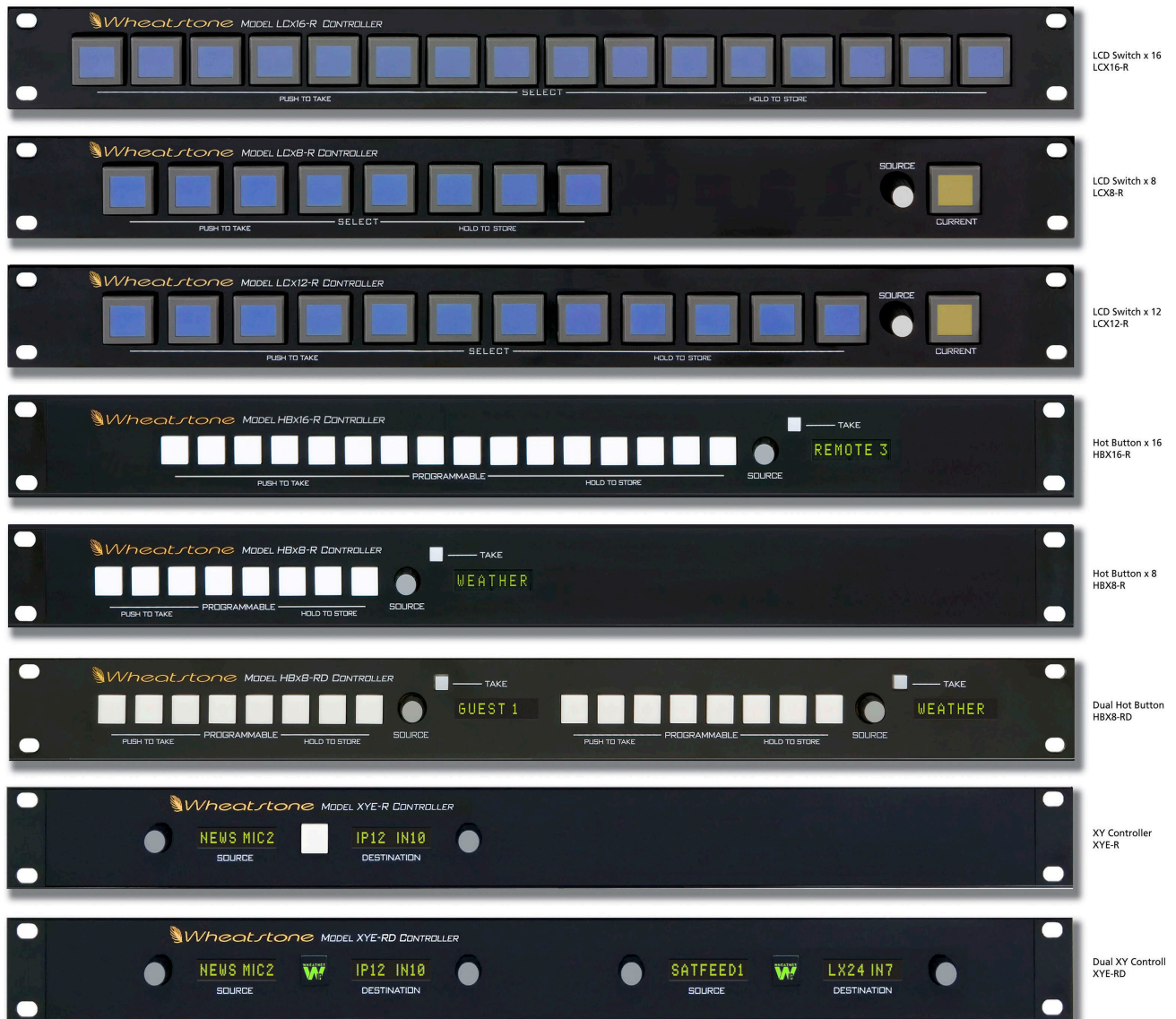

All X-Y crosspoint controllers have similar functions. First, select a **DESTINATION** (console fader, recorder, etc.) by turning the **DESTINATION** knob. By turning the **SOURCE** knob, the available inputs are displayed in the 8-character display window and the **TAKE** button lights. When the desired input source is scrolled into the display window, pressing the **TAKE** button will execute the take command on the downstroke. The **TAKE** button light goes off and the desired input source is selected. Note that if the **TAKE** button is not pressed in a timeout period of 6-8 seconds, the display will revert to its previous setting.

Some controllers have **PROGRAMMABLE** buttons to program input sources. To program the desired input source for a selected button, press the button and hold it for a few seconds. The display window will display **<STORED>**, and the desired input source will be stored for this button.

When the **SOURCE** knob is scrolled to a programmed input source, the associated button lights to indicate the correspondence between the source and button.

The Ethernet-Based Controllers connect to your LAN via standard UTP CAT-5 “straight” cables terminated with RJ-45 connectors..

Hardware

Chapter Contents

Chassis/Backplane Overview	2-6
Chassis Configuration Guidelines	2-7
Audio Slots	2-7
Reserved Slots	2-7
Digital Input Card (AES-2024)	
Overview	2-8
AES Input Interface	2-8
Internal Programming Options	2-8
Status LED's	2-9
Hook-Ups	
DB-25 (for AES-2024/8) - Digital Audio Connections	2-10
2DB-25 (for AES-2024/16) - Digital Audio Connections	2-10
8BNC - Digital Audio Connections	2-12
8RJ-45 - Digital Audio Connections.....	2-12
DB Panel Pinout Drawing	2-14
2DB Panel Pinout Drawing	2-15
8BNC Panel Pinout Drawing	2-16
8RJ Panel Pinout Drawing	2-17
Analog Input Card (ADI-2001)	
Overview	2-18
Analog Input Interface	2-18
Internal Programming Options	2-18
Status LED's	2-19
Hook-Ups	
Upper DB-25 - Analog Audio Connections	2-20
Lower DB-25 - Analog Audio Connections	2-20
8RJ-45 - Analog Audio Connections.....	2-21
2DB Panel Pinout Drawing	2-22
8RJ Panel Pinout Drawing	2-23

Digital Output Card (DO-2016)	
Overview	2-24
AES Output Interface	2-24
AES Channel Status Implementation	2-25
Internal Programming Options	2-25
Status LED's	2-26
Hook-Ups	
DB-25 (for DO-2016/8) - Digital Audio Connections	2-27
2DB-25 (for DO-2016/16) - Digital Audio Connections	2-27
8BNC - Digital Audio Connections	2-29
8RJ-45 - Digital Audio Connections.....	2-29
DB Panel Pinout Drawing	2-31
2DB Panel Pinout Drawing	2-32
8BNC Panel Pinout Drawing	2-33
8RJ Panel Pinout Drawing	2-34
Analog Output Card (AO-2001)	
Overview	2-35
Analog Output Interface	2-35
Internal Programming Options	2-35
Status LED's	2-36
Hook-Ups	
Upper DB-25 - Analog Audio Connections	2-37
Lower DB-25 - Analog Audio Connections	2-37
8RJ-45 - Analog Audio Connections.....	2-38
2DB Panel Pinout Drawing	2-39
8RJ Panel Pinout Drawing	2-40
Microphone Card (MIC-2001)	
Overview	2-41
Analog Input Interface	2-41
Internal Programming Options	2-41
Status LED's	2-42
Hook-Ups	
Upper DB-25 - Analog Audio Input Connections.....	2-43
Lower DB-25 - Analog Audio Output Connections	2-43
8RJ-45 - Analog Audio Connections.....	2-44
2DB Panel Pinout Drawing	2-45
8RJ Panel Pinout Drawing	2-46

Host CPU (CPU-2001)	
Overview	2-47
Multi CPU/Failover CPU Systems	2-47
CPU-2001 BIOS Settings/Format	2-47
Ethernet IP Addressing	2-48
Ethernet Interface Wiring	2-48
Internal Programming Options	2-48
Switch Settings	2-49
Jumper Settings	2-50
Status LED's	2-51
Hook-Ups	
“IN” and “OUT” BNC - DARS Connections	2-52
RJ-45 - Ethernet Connections	2-52
Typical Straight-Through Cable.....	2-53
Typical Crossover Cable.....	2-53
HCI Panel Pinout Drawing	2-54
Legacy HCI Panel Pinout Drawing	2-54a
Quad Audio Network Card (QAT-2001)	
Overview	2-55
Internal Programming Options	2-57
Switch Settings	2-57
Jumper Settings	2-59
Status LED's	2-60
Hook-Ups	
QCT-2001 - “A”, “B”, “C”, “D” RJ-45 - CAT5/6 Audio Network Connections	2-62
Optical Fiber Interface	2-63
QOT-2001	2-63
QFT-2001	2-64
Logic I/O Card (LIO-2001)	
Overview	2-66
Input Ports	2-66
Output Ports	2-67
Typical Input/Output Circuit	2-67
Mic Logic Interface	2-68
Software Programming	2-69
Internal Programming Options	2-69
Jumper/Dipswitch Settings	2-69
Status LED's	2-70

Hook-Ups	2-71
Upper DB-25 - Logic In Ports Connections	2-71
Lower DB-25 - Logic Out Ports Connections	2-71
LRJ-2001 - Logic I/O Connections	2-72
LIO (2DB) Panel Pinout Drawing	2-74
LRJ Panel Pinout Drawing	2-75
Digital Signal Processor Card (DSP-2001)	
Overview	2-76
Internal Programming Options	2-76
Switch Settings	2-77
Jumper Settings	2-77
Status LED's	2-78
Mix Engine Digital Signal Processor Card (DSP-2009)	
Overview	2-79
Internal Programming Options	2-79
Switch Settings	2-80
Jumper Settings	2-80
Status LED's	2-81
Serial Digital Interface Card (SDI-2001)	
Overview	2-82
Format and Standards Compliance	2-82
Physical Interface	2-82
Synchronization	2-82
SDI Card Configuration	2-83
AES Group Selection	2-83
Audio Signal Mapping	2-84
Audio Signal Creation	2-84
Stereo Signal Example	2-84
Surround Signal Example	2-85
Internal Programming Options	2-85
Status LED's	2-86
Hook-Ups	2-87
SDI - Serial Video Connections	2-87

Multichannel Audio Digital Interface Card (MADI-2001)

Overview	2-88
Format and Standards Compliance	2-88
Physical Interface	2-88
Synchronization	2-89
MADI Card Configuration	2-89
Audio Signal Mapping	2-90
Audio Signal Creation	2-90
Mono Signal Example	2-90
Stereo Signal Example	2-91
Internal Programming Options	2-91
Status LED's	2-92
Hook-Ups	2-93
Digital Audio Connections.....	2-93
Optical Fiber Interface.....	2-93



Hardware

Chassis/Backplane Overview

The GIBALTAR NETWORK router chassis may be configured to suit a variety of I/O card complements including analog or digital audio input and output cards, chassis expansion and audio network cards, DSP mix engine cards, and logic I/O cards. A system may include a single cage, multiple co-located cages, or a central chassis connected to one or more GIBALTAR NETWORK frames in a star configuration. All audio input and output signal connections are made via a family of I/O connector modules that plug into the rear of the chassis. Power supply, serial control, audio network, and ethernet connections are also made on the rear of the chassis.

The backplane itself is entirely connectorized and contains a minimal number of passive components. Further, the backplane assembly may be removed rather easily in the rare case that service is required.

Chassis Configuration Guidelines

While new GIBRALTAR NETWORK systems are pre-configured to customer specifications at Wheatstone's factory, future expansion of a system may require some re-configuration of existing hardware to accommodate new resources.

Audio Slots

Audio I/O cards may be mounted in almost any slot, though there are some basic guidelines to take into account when filling a master or remote chassis. The main thing you should know is that each input or output card uses up some of the backplane resources in the Tier. Inputs use TDM busses and output cards use Output Blocks; there are 32 TDM busses and 32 Output Blocks per Tier. Digital audio from each input card is driven on to a specific TDM bus (physical wire) on the backplane. Output cards use Output Blocks to pick off the audio from any of the sixteen channels of a TDM bus.

Before adding a card, check the "config.txt" file located in your XPoint configuration folder to see if there are enough resources available in the rack. You could also try adding the card; XPoint will tell you if try to exceed the available resource limit. Every audio input card uses at least one TDM, and every output card uses at least one Output Block. 16 channel AES I/O cards use 2 TDM's and 2 Output Blocks respectively. Analog output cards with the Mono Summing feature enabled use 2 Output Blocks.

Reserved Slots

Slot 16 in a GIBRALTAR NETWORK cage is generally reserved for a host CPU card, although a DSP card may be installed in certain cases. Audio Network cards are generally installed beginning at slot 1 of each 16 slot GIBRALTAR NETWORK chassis.

Digital Input Card (AES-2024)

Overview

There are two versions of digital audio input cards for the GIBRALTAR NETWORK:

- AES-2024/8 card will accept up to 8 AES-3 formatted stereo sources (i.e. 16 mono *channels*).
- AES-2024/16 card will accept up to 16 AES-3 formatted stereo sources (i.e. 32 mono *channels*)
- A *Signal Definitions* form in the supplied XPoint software allows the user to set attributes for the input channels, including signal name, type, circuit #, etc. The 16 (32) input *channels* may be configured as mono *signals* (one channel), stereo *signals* (two channels), or 5.1 surround sound *signals* (six channels), wired in any combination. Signals may span across input cards (e.g. a surround sound *signal* may have 2 *channels* on one input card, and 4 on a different input card).

NOTE: While it is possible to split the 8 (16) stereo AES inputs into 16 (32) mono channels, there are still only 8 (16) physical wires, each containing the 2-channel AES formatted data.

A dedicated sample rate converter for each input re-clocks the incoming audio data and phase locks it to the system's master sample rate clock. Embedded logic routes each channel of audio data into an available time slot of the input card's TDM bus. One TDM bus is allocated for each 8 input card, and 2 TDM's are used by the 16 input card.

AES Input Interface

The balanced digital audio inputs on the AES-2024 card are transformer coupled. AES receivers strip off the received sample rate clock and audio data for further processing by sample rate converters. The balanced interface operates at a nominal peak-to-peak input voltage of +5V with an input impedance of 110 Ω and conforms to the AES-3 1992 electrical specification. Note that Channel Status data is not forwarded.

While unbalanced SPDIF formatted input signals may be connected to the HI and LO inputs of an AES input channel (leave the shield floating), it is recommended that a BALUN or other external matching device be inserted to convert the SPDIF impedance to 110 Ω and signal level to at least 1V p-p. Note that the optional BNC rear panel input impedance is internally fixed at 75 Ω .

Internal Programming Options

There are no internal programming options on the AES-2024 input card.

Digital Input Card Status LED's

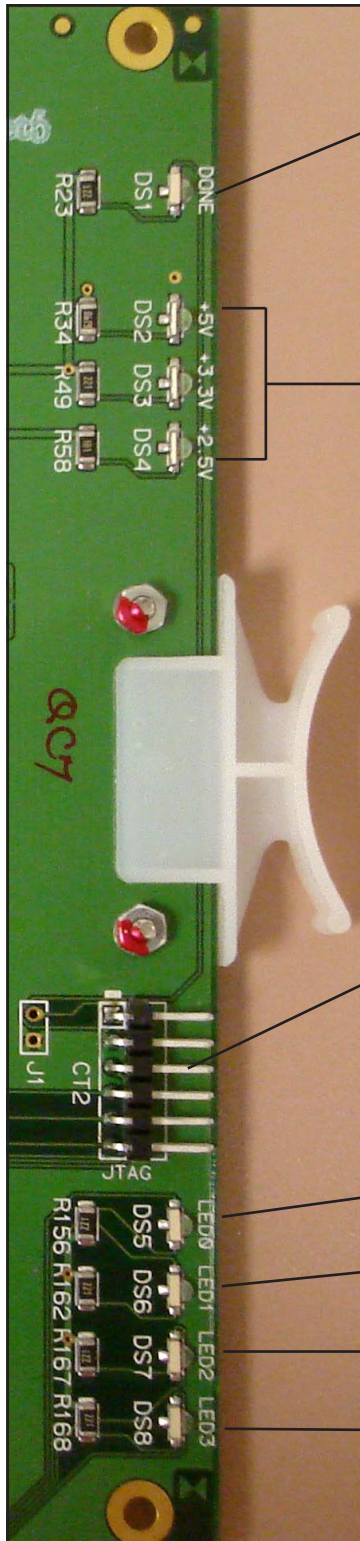

DONE LED (DS1) - Normally OFF;
ON when programming the FPGA,
Flashes when system clock is missing.

POWER SUPPLY STATUS (DS2-DS4) - ON indicates power
supply is OK.

JTAG HEADER - FPGA programming - factory use only.

AUXILIARY STATUS LED's

ACTIVITY LED (DS5) - Flashes on messages.

DS6 - Not Used

MUTE STATUS (DS7) - ON when the input channels are muted.

CFG STATUS (DS8) - ON when card is not configured.

Hook-Ups

All user wiring to the AES-2024 card takes place at the rear I/O connector modules: DB, 2DB, 8BNC, or 8RJ-45. The DB module has one female DB-25 connector and the 2DB has two DB connectors for audio input connections. The BNC module contains eight BNC connectors for use with 75 ohm digital audio equipment; likewise the 8RJ-45 module contains eight RJ-45 connectors for use in balanced, unshielded twisted pair (UTP) wiring systems.

DB-25 (for AES-2024/8) – Digital Audio Connections

These include eight input sources. Pinout drawing on page 2-14 shows all wiring connections at a glance.

Pin 24 – HI	}	AES 1 In
Pin 12 – LO		
Pin 25 – SH		
Pin 10 – HI	}	AES 2 In
Pin 23 – LO		
Pin 11 – SH		
Pin 21 – HI	}	AES 3 In
Pin 9 – LO		
Pin 22 – SH		
Pin 7 – HI	}	AES 4 In
Pin 20 – LO		
Pin 8 – SH		
Pin 18 – HI	}	AES 5 In
Pin 6 – LO		
Pin 19 – SH		
Pin 4 – HI	}	AES 6 In
Pin 17 – LO		
Pin 5 – SH		
Pin 15 – HI	}	AES 7 In
Pin 3 – LO		
Pin 16 – SH		
Pin 1 – HI	}	AES 8 In
Pin 14 – LO		
Pin 2 – SH		

2DB-25 (for AES-2024/16) – Digital Audio Connections

Upper DB-25 include eight (1-8) input sources. Pinout drawing on page 2-15 shows all wiring connections at a glance.

Pin 24 – HI	}	AES 1 In
Pin 12 – LO		
Pin 25 – SH		
Pin 10 – HI	}	AES 2 In
Pin 23 – LO		
Pin 11 – SH		

Pin 21 – HI	}	AES 3 In
Pin 9 – LO		
Pin 22 – SH		
Pin 7 – HI	}	AES 4 In
Pin 20 – LO		
Pin 8 – SH		
Pin 18 – HI	}	AES 5 In
Pin 6 – LO		
Pin 19 – SH		
Pin 4 – HI	}	AES 6 In
Pin 17 – LO		
Pin 5 – SH		
Pin 15 – HI	}	AES 7 In
Pin 3 – LO		
Pin 16 – SH		
Pin 1 – HI	}	AES 8 In
Pin 14 – LO		
Pin 2 – SH		

Lower DB-25 include eight (9-16) input sources. Pinout drawing on page 2-15 shows all wiring connections at a glance.

Pin 24 – HI	}	AES 9 In
Pin 12 – LO		
Pin 25 – SH		
Pin 10 – HI	}	AES 10 In
Pin 23 – LO		
Pin 11 – SH		
Pin 21 – HI	}	AES 11 In
Pin 9 – LO		
Pin 22 – SH		
Pin 7 – HI	}	AES 12 In
Pin 20 – LO		
Pin 8 – SH		
Pin 18 – HI	}	AES 13 In
Pin 6 – LO		
Pin 19 – SH		
Pin 4 – HI	}	AES 14 In
Pin 17 – LO		
Pin 5 – SH		
Pin 15 – HI	}	AES 15 In
Pin 3 – LO		
Pin 16 – SH		
Pin 1 – HI	}	AES 16 In
Pin 14 – LO		
Pin 2 – SH		

8BNC – Digital Audio Connections

This panel is used only for the AES-2024/8 card. Pinout drawing on page 2-16 shows all wiring connections at a glance.

BNC 1 Pin 1 – HI]	AES 1 In
BNC 1 Pin 2 – SH		
BNC 2 Pin 1 – HI]	AES 2 In
BNC 2 Pin 2 – SH		
BNC 3 Pin 1 – HI]	AES 3 In
BNC 3 Pin 2 – SH		
BNC 4 Pin 1 – HI]	AES 4 In
BNC 4 Pin 2 – SH		
BNC 5 Pin 1 – HI]	AES 5 In
BNC 5 Pin 2 – SH		
BNC 6 Pin 1 – HI]	AES 6 In
BNC 6 Pin 2 – SH		
BNC 7 Pin 1 – HI]	AES 7 In
BNC 7 Pin 2 – SH		
BNC 8 Pin 1 – HI]	AES 8 In
BNC 8 Pin 2 – SH		

8RJ-45 – Digital Audio Connections

For AES-2024/8 digital input connections use RJ-45 #1-4 connectors, and for AES-2024/16 use RJ-45 #1-8 connectors. Pinout drawing on page 2-17 shows all wiring connections at a glance.

RJ-45#1 Pin 1 – HI]	AES 1 In
RJ-45#1 Pin 2 – LO		
RJ-45#1 Pin 3 – HI]	AES 2 In
RJ-45#1 Pin 6 – LO		
RJ-45#2 Pin 1 – HI]	AES 3 In
RJ-45#2 Pin 2 – LO		
RJ-45#2 Pin 3 – HI]	AES 4 In
RJ-45#2 Pin 6 – LO		
RJ-45#3 Pin 1 – HI]	AES 5 In
RJ-45#3 Pin 2 – LO		
RJ-45#3 Pin 3 – HI]	AES 6 In
RJ-45#3 Pin 6 – LO		
RJ-45#4 Pin 1 – HI]	AES 7 In
RJ-45#4 Pin 2 – LO		
RJ-45#4 Pin 3 – HI]	AES 8 In
RJ-45#4 Pin 6 – LO		
RJ-45#5 Pin 1 – HI]	AES 9 In
RJ-45#5 Pin 2 – LO		
RJ-45#5 Pin 3 – HI]	AES 10 In
RJ-45#5 Pin 6 – LO		

RJ-45#6 Pin 1 – HI]	AES 11 In
RJ-45#6 Pin 2 – LO		
RJ-45#6 Pin 3 – HI]	AES 12 In
RJ-45#6 Pin 6 – LO		
RJ-45#7 Pin 1 – HI]	AES 13 In
RJ-45#7 Pin 2 – LO		
RJ-45#7 Pin 3 – HI]	AES 14 In
RJ-45#7 Pin 6 – LO		
RJ-45#8 Pin 1 – HI]	AES 15 In
RJ-45#8 Pin 2 – LO		
RJ-45#8 Pin 3 – HI]	AES 16 In
RJ-45#8 Pin 6 – LO		

DB Panel Digital Input Connections for AES-2024/8



“A” DB-25

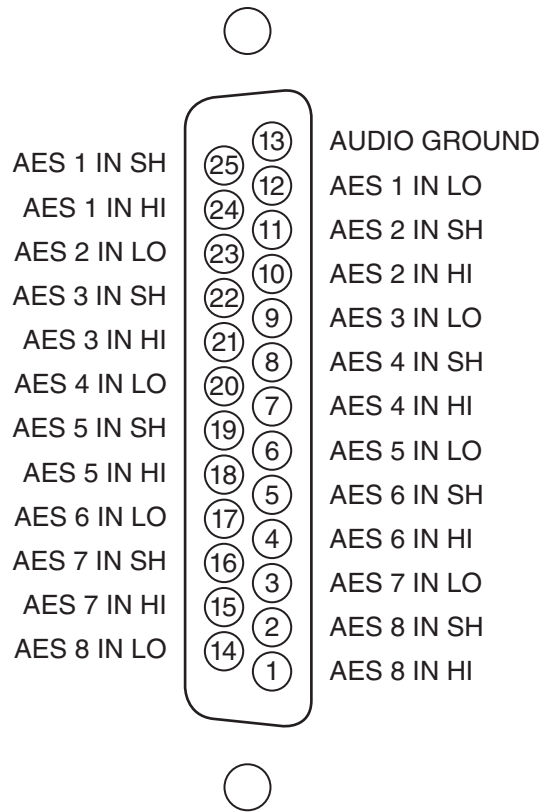

2DB Panel Digital Input Connections for AES-2024/16

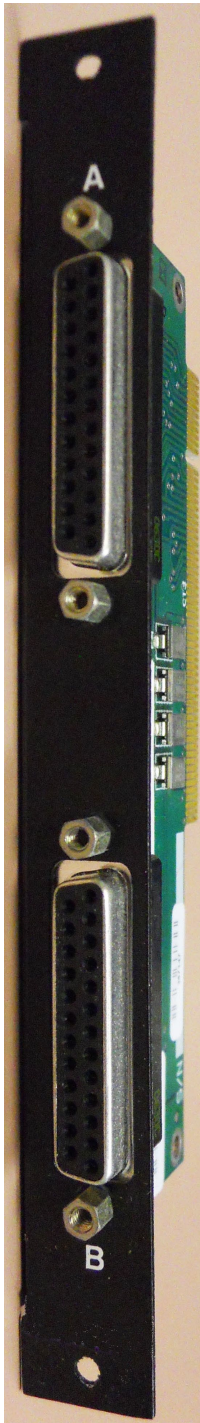

*Upper "A"
DB-25*

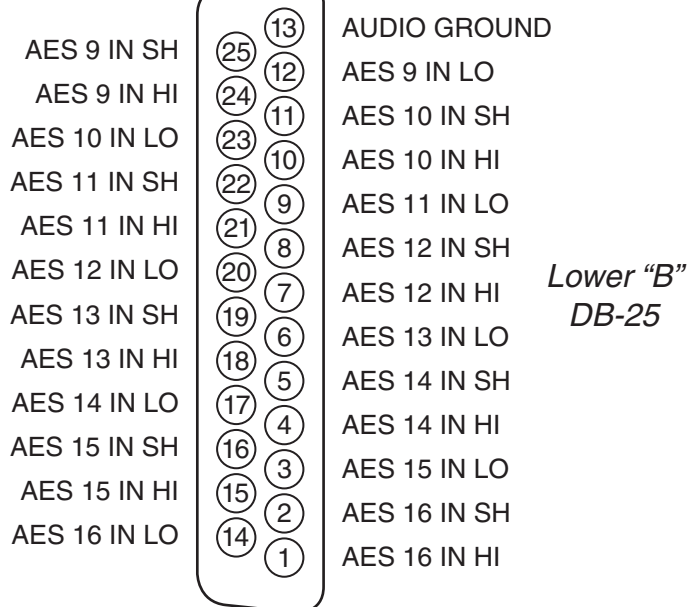
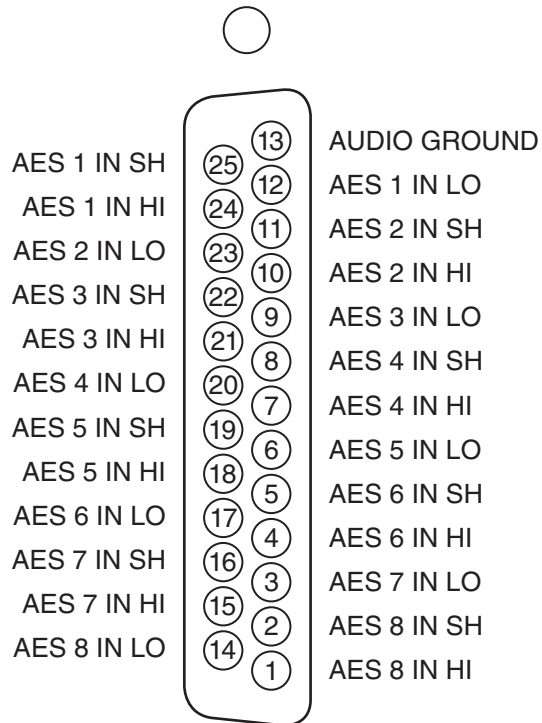

*Lower "B"
DB-25*

8BNC Panel Digital Input Connections for AES-2024/8

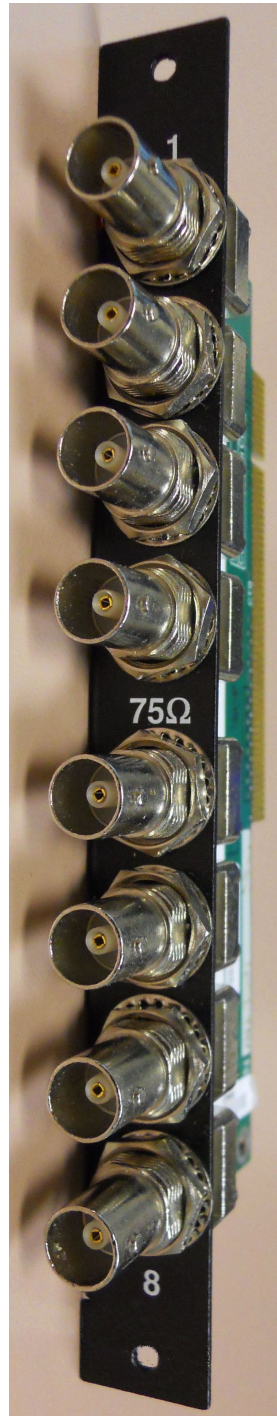

HI
SH AES 1 IN

HI
SH AES 2 IN

HI
SH AES 3 IN

HI
SH AES 4 IN

HI
SH AES 5 IN

HI
SH AES 6 IN

HI
SH AES 7 IN

HI
SH AES 8 IN

8RJ Panel Digital Input Connections

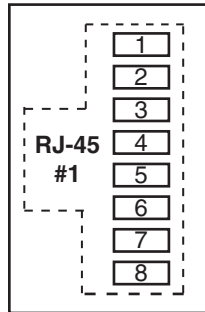
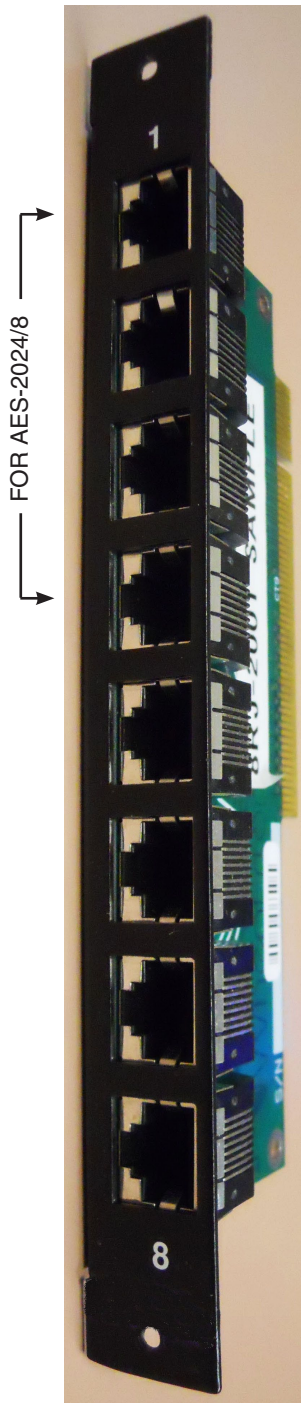

AES 1 IN HI
AES 1 IN LO
AES 2 IN HI
AES 2 IN LO

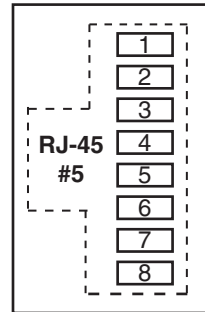

AES 9 IN HI
AES 9 IN LO
AES 10 IN HI
AES 10 IN LO

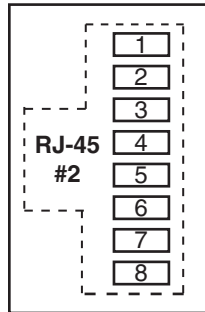

AES 3 IN HI
AES 3 IN LO
AES 4 IN HI
AES 4 IN LO

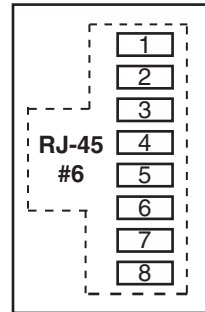

AES 11 IN HI
AES 11 IN LO
AES 12 IN HI
AES 12 IN LO

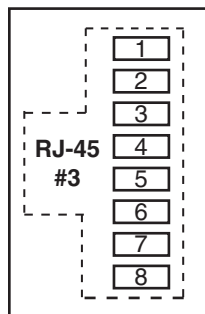

AES 5 IN HI
AES 5 IN LO
AES 6 IN HI
AES 6 IN LO

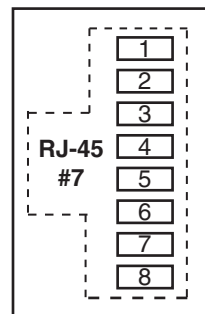

AES 13 IN HI
AES 13 IN LO
AES 14 IN HI
AES 14 IN LO

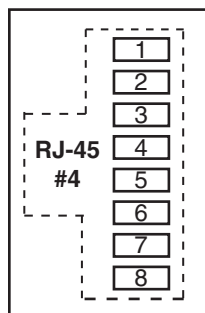

AES 7 IN HI
AES 7 IN LO
AES 8 IN HI
AES 8 IN LO

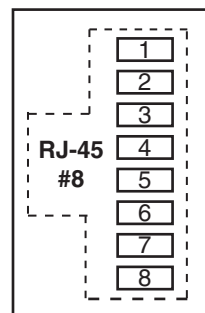

AES 15 IN HI
AES 15 IN LO
AES 16 IN HI
AES 16 IN LO

Analog Input Card (ADI-2001)

Overview

The Analog input card accepts up to 8 stereo analog audio sources (i.e.16 mono *channels*). A *Signal Definitions* form in the supplied XPoint software allows the user to set attributes for the input channel hardware, including signal name, type, circuit #, etc. The 16 input *channels* may be configured as mono *signals* (one channel), stereo *signals* (two channels), or 5.1 surround sound *signals* (six channels) in any combination. Signals may span across input cards (e.g. a surround sound *signal* may have 4 *channels* on one input card, and 2 channels on a different input card).

The balanced, line level analog input signals are buffered and converted to the digital domain by 24bit A-D converters operating at the system's master sample rate. Embedded logic routes each channel of audio data into an available time slot of the input card's TDM bus. One TDM bus is allocated for each input card.

Analog Input Interface

The balanced analog input stages are direct coupled, unity gain circuits and operate at a nominal input level of +4dBu. The input impedance is 20k Ω . A +4dBu input signal will result in a -20dBFS digital output level at any of the selected AES outputs. The maximum analog input signal level is +24 dBu, providing 20 dB of headroom above the nominal input level.

Reference Notes:

0dBu = .7746 V RMS, +4dBu = 1.23V RMS

dBFS = dB Full Scale Digital

-20dBFS = +4dBu

Internal Programming Options

There are no internal programming options on the ADI-2001 card.

Analog Input Card Status LED's

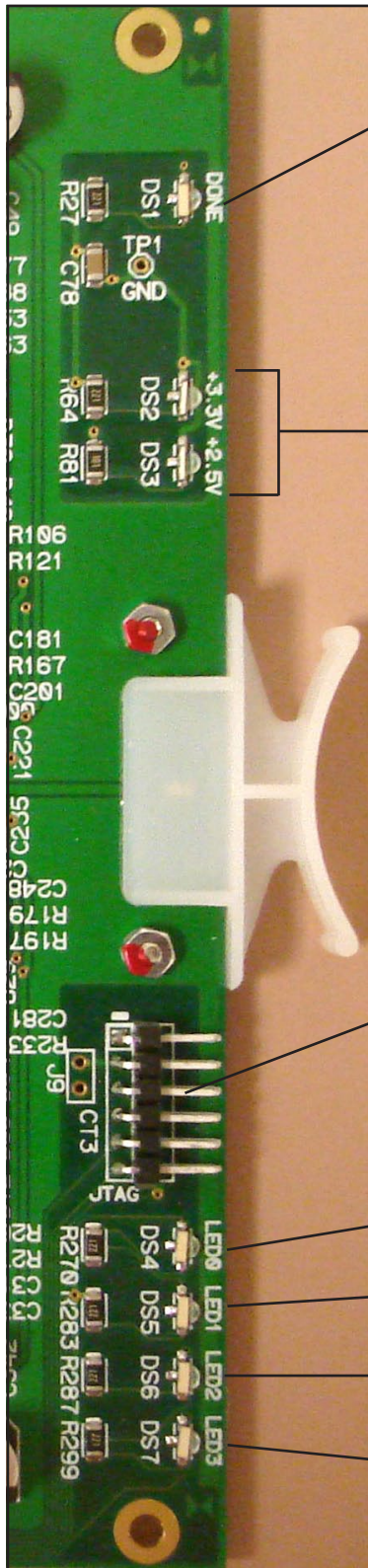

DONE LED (DS1) - Normally OFF;
ON when programming the FPGA,
Flashes when system clock is missing.

POWER SUPPLY STATUS (DS2, DS3) - ON indicates power
supply is OK.

JTAG HEADER - FPGA programming - factory use only.

AUXILIARY STATUS LED's

ACTIVITY LED (DS4) - Flashes on messages.

DS5 - Not Used

MUTE STATUS (DS6) - ON when the input channels are muted.

CFG STATUS (DS7) - ON when card is not configured.

Hook-Ups

All user wiring to the ADI-2001 card takes place at the rear I/O connector modules: 2DB or 8RJ-45. The 2DB module has two female DB-25 connectors for audio input connections. The 8RJ-45 module contains eight RJ-45 connectors for use in balanced, unshielded twisted pair (UTP) wiring systems.

Upper DB-25 – Analog Audio Connections

These include four (1-4) input sources. Pinout drawing on page 2-22 shows all wiring connections at a glance.

Pin 24 – HI	}	Channel 1 (Stereo 1 Lt) In
Pin 12 – LO		
Pin 25 – SH		
Pin 10 – HI	}	Channel 2 (Stereo 1 Rt) In
Pin 23 – LO		
Pin 11 – SH		
Pin 21 – HI	}	Channel 3 (Stereo 2 Lt) In
Pin 9 – LO		
Pin 22 – SH		
Pin 7 – HI	}	Channel 4 (Stereo 2 Rt) In
Pin 20 – LO		
Pin 8 – SH		
Pin 18 – HI	}	Channel 5 (Stereo 3 Lt) In
Pin 6 – LO		
Pin 19 – SH		
Pin 4 – HI	}	Channel 6 (Stereo 3 Rt) In
Pin 17 – LO		
Pin 5 – SH		
Pin 15 – HI	}	Channel 7 (Stereo 4 Lt) In
Pin 3 – LO		
Pin 16 – SH		
Pin 1 – HI	}	Channel 8 (Stereo 4 Rt) In
Pin 14 – LO		
Pin 2 – SH		

Lower DB-25 – Analog Audio Connections

These include four (5-8) input sources. Pinout drawing on page 2-22 shows all wiring connections at a glance.

Pin 24 – HI	}	Channel 9 (Stereo 5 Lt) In
Pin 12 – LO		
Pin 25 – SH		
Pin 10 – HI	}	Channel 10 (Stereo 5 Rt) In
Pin 23 – LO		
Pin 11 – SH		
Pin 21 – HI	}	Channel 11 (Stereo 6 Lt) In
Pin 9 – LO		
Pin 22 – SH		

Pin 7 – HI	}	Channel 12 (Stereo 6 Rt) In
Pin 20 – LO		
Pin 8 – SH		
Pin 18 – HI	}	Channel 13 (Stereo 7 Lt) In
Pin 6 – LO		
Pin 19 – SH		
Pin 4 – HI	}	Channel 14 (Stereo 7 Rt) In
Pin 17 – LO		
Pin 5 – SH		
Pin 15 – HI	}	Channel 15 (Stereo 8 Lt) In
Pin 3 – LO		
Pin 16 – SH		
Pin 1 – HI	}	Channel 16 (Stereo 8 Rt) In
Pin 14 – LO		
Pin 2 – SH		

8RJ-45 – Analog Audio Connections

Pinout drawing on pages 2-23 shows all wiring connections at a glance.

RJ-45#1 Pin 1 – HI	}	Channel 1 (Stereo 1 Lt) In
RJ-45#1 Pin 2 – LO		
RJ-45#1 Pin 3 – HI	}	Channel 2 (Stereo 1 Rt) In
RJ-45#1 Pin 6 – LO		
RJ-45#2 Pin 1 – HI	}	Channel 3 (Stereo 2 Lt) In
RJ-45#2 Pin 2 – LO		
RJ-45#2 Pin 3 – HI	}	Channel 4 (Stereo 2 Rt) In
RJ-45#2 Pin 6 – LO		
RJ-45#3 Pin 1 – HI	}	Channel 5 (Stereo 3 Lt) In
RJ-45#3 Pin 2 – LO		
RJ-45#3 Pin 3 – HI	}	Channel 6 (Stereo 3 Rt) In
RJ-45#3 Pin 6 – LO		
RJ-45#4 Pin 1 – HI	}	Channel 7 (Stereo 4 Lt) In
RJ-45#4 Pin 2 – LO		
RJ-45#4 Pin 3 – HI	}	Channel 8 (Stereo 4 Rt) In
RJ-45#4 Pin 6 – LO		
RJ-45#5 Pin 1 – HI	}	Channel 9 (Stereo 5 Lt) In
RJ-45#5 Pin 2 – LO		
RJ-45#5 Pin 3 – HI	}	Channel 10 (Stereo 5 Rt) In
RJ-45#5 Pin 6 – LO		
RJ-45#6 Pin 1 – HI	}	Channel 11 (Stereo 6 Lt) In
RJ-45#6 Pin 2 – LO		
RJ-45#6 Pin 3 – HI	}	Channel 12 (Stereo 6 Rt) In
RJ-45#6 Pin 6 – LO		
RJ-45#7 Pin 1 – HI	}	Channel 13 (Stereo 7 Lt) In
RJ-45#7 Pin 2 – LO		
RJ-45#7 Pin 3 – HI	}	Channel 14 (Stereo 7 Rt) In
RJ-45#7 Pin 6 – LO		
RJ-45#8 Pin 1 – HI	}	Channel 15 (Stereo 8 Lt) In
RJ-45#8 Pin 2 – LO		
RJ-45#8 Pin 3 – HI	}	Channel 16 (Stereo 8 Rt) In
RJ-45#8 Pin 6 – LO		

2DB Panel Analog Input Connections

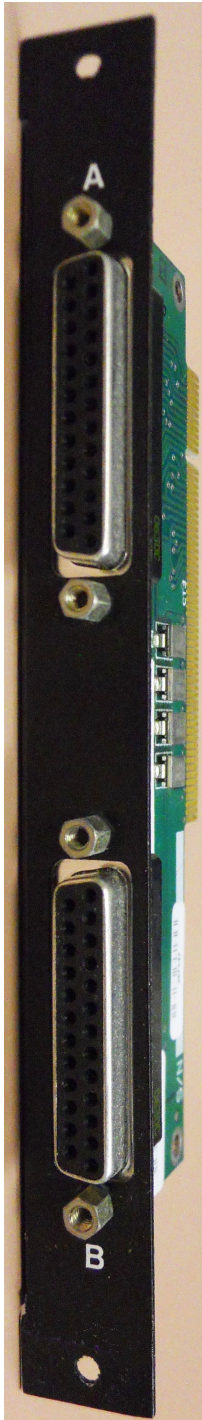

*Upper "A"
DB-25*

CHANNEL 1 (STEREO 1 LT) IN SH
 CHANNEL 1 (STEREO 1 LT) IN HI
 CHANNEL 2 (STEREO 1 RT) IN LO
 CHANNEL 2 (STEREO 1 RT) IN HI
 CHANNEL 3 (STEREO 2 LT) IN SH
 CHANNEL 3 (STEREO 2 LT) IN HI
 CHANNEL 4 (STEREO 2 RT) IN LO
 CHANNEL 4 (STEREO 2 RT) IN HI
 CHANNEL 5 (STEREO 3 LT) IN SH
 CHANNEL 5 (STEREO 3 LT) IN HI
 CHANNEL 6 (STEREO 3 RT) IN LO
 CHANNEL 6 (STEREO 3 RT) IN HI
 CHANNEL 7 (STEREO 4 LT) IN SH
 CHANNEL 7 (STEREO 4 LT) IN HI
 CHANNEL 8 (STEREO 4 RT) IN LO

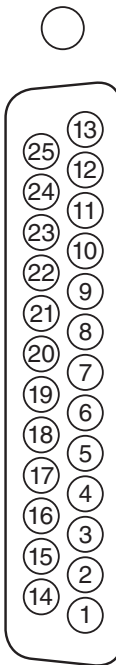

AUDIO GROUND
 CHANNEL 1 (STEREO 1 LT) IN LO
 CHANNEL 2 (STEREO 1 RT) IN SH
 CHANNEL 2 (STEREO 1 RT) IN HI
 CHANNEL 3 (STEREO 2 LT) IN LO
 CHANNEL 4 (STEREO 2 RT) IN SH
 CHANNEL 4 (STEREO 2 RT) IN HI
 CHANNEL 5 (STEREO 3 LT) IN LO
 CHANNEL 6 (STEREO 3 RT) IN SH
 CHANNEL 6 (STEREO 3 RT) IN HI
 CHANNEL 7 (STEREO 4 LT) IN LO
 CHANNEL 8 (STEREO 4 RT) IN SH
 CHANNEL 8 (STEREO 4 RT) IN HI

CHANNEL 9 (STEREO 5 LT) IN SH
 CHANNEL 9 (STEREO 5 LT) IN HI
 CHANNEL 10 (STEREO 5 RT) IN LO
 CHANNEL 10 (STEREO 5 RT) IN HI
 CHANNEL 11 (STEREO 6 LT) IN SH
 CHANNEL 11 (STEREO 6 LT) IN HI
 CHANNEL 12 (STEREO 6 RT) IN LO
 CHANNEL 12 (STEREO 6 RT) IN HI
 CHANNEL 13 (STEREO 7 LT) IN SH
 CHANNEL 13 (STEREO 7 LT) IN HI
 CHANNEL 14 (STEREO 7 RT) IN LO
 CHANNEL 14 (STEREO 7 RT) IN HI
 CHANNEL 15 (STEREO 8 LT) IN SH
 CHANNEL 15 (STEREO 8 LT) IN HI
 CHANNEL 16 (STEREO 8 RT) IN LO

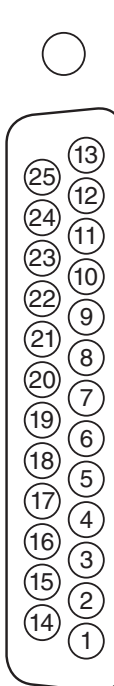

AUDIO GROUND
 CHANNEL 9 (STEREO 5 LT) IN LO
 CHANNEL 10 (STEREO 5 RT) IN SH
 CHANNEL 10 (STEREO 5 RT) IN HI
 CHANNEL 11 (STEREO 6 LT) IN LO
 CHANNEL 12 (STEREO 6 RT) IN SH
 CHANNEL 12 (STEREO 6 RT) IN HI
 CHANNEL 13 (STEREO 7 LT) IN LO
 CHANNEL 14 (STEREO 7 RT) IN SH
 CHANNEL 14 (STEREO 7 RT) IN HI
 CHANNEL 15 (STEREO 8 LT) IN LO
 CHANNEL 16 (STEREO 8 RT) IN SH
 CHANNEL 16 (STEREO 8 RT) IN HI

*Lower "B"
DB-25*

8RJ Panel

Analog Input Connections

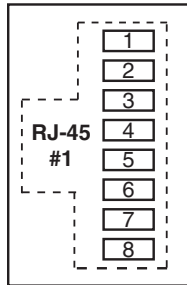

CHANNEL 1 (STEREO 1 LT) IN HI
 CHANNEL 1 (STEREO 1 LT) IN LO
 CHANNEL 2 (STEREO 1 RT) IN HI
 CHANNEL 2 (STEREO 1 RT) IN LO

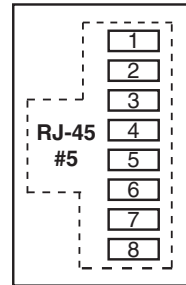

CHANNEL 9 (STEREO 5 LT) IN HI
 CHANNEL 9 (STEREO 5 LT) IN LO
 CHANNEL 10 (STEREO 5 RT) IN HI
 CHANNEL 10 (STEREO 5 RT) IN LO

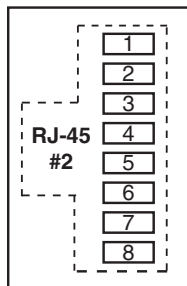

CHANNEL 3 (STEREO 2 LT) IN HI
 CHANNEL 3 (STEREO 2 LT) IN LO
 CHANNEL 4 (STEREO 2 RT) IN HI
 CHANNEL 4 (STEREO 2 RT) IN LO

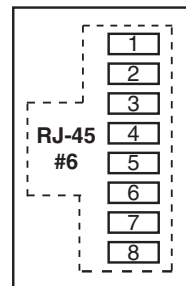

CHANNEL 11 (STEREO 6 LT) IN HI
 CHANNEL 11 (STEREO 6 LT) IN LO
 CHANNEL 12 (STEREO 6 RT) IN HI
 CHANNEL 12 (STEREO 6 RT) IN LO

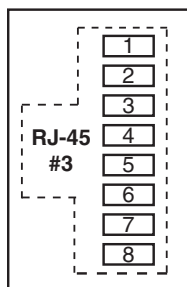

CHANNEL 5 (STEREO 3 LT) IN HI
 CHANNEL 5 (STEREO 3 LT) IN LO
 CHANNEL 6 (STEREO 3 RT) IN HI
 CHANNEL 6 (STEREO 3 RT) IN LO

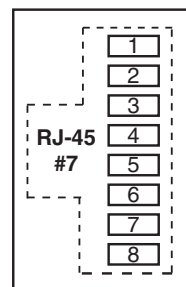

CHANNEL 13 (STEREO 7 LT) IN HI
 CHANNEL 13 (STEREO 7 LT) IN LO
 CHANNEL 14 (STEREO 7 RT) IN HI
 CHANNEL 14 (STEREO 7 RT) IN LO

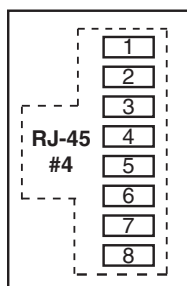

CHANNEL 7 (STEREO 4 LT) IN HI
 CHANNEL 7 (STEREO 4 LT) IN LO
 CHANNEL 8 (STEREO 4 RT) IN HI
 CHANNEL 8 (STEREO 4 RT) IN LO

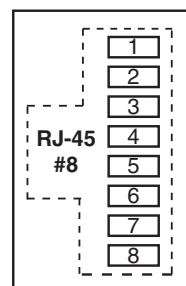

CHANNEL 15 (STEREO 8 LT) IN HI
 CHANNEL 15 (STEREO 8 LT) IN LO
 CHANNEL 16 (STEREO 8 RT) IN HI
 CHANNEL 16 (STEREO 8 RT) IN LO

Digital Output Card (DO-2016)

Overview

There are two versions of digital output cards for the GIBALTAR:

- DO-2016/8 card provides 8 physical AES-3 formatted outputs (i.e. 16 mono channels or circuits in software).
- DO-2016/16 card provides 16 physical AES-3 formatted outputs (i.e. 32 mono channels or circuits in software).

A *Signal Definitions* form in the supplied XPoint software allows the user to set attributes for the output channels, including signal name, type, circuit #, etc. The 8 (16) AES outputs are configured in software to be any combination of mono, stereo, or 5.1 *output signals*. For example, the card is normally configured as 8 (16) stereo outputs, but might also be configured as 4 (8) stereo outputs and 8 (16) mono outputs. Many combinations are possible up to the card's 16 (32) channel limit. 5.1 signals may span across two DO-2016 output cards.

Each output card listens for connection commands from the CPU card, and then uses this information to connect the appropriate sources to their selected output channels. The selected audio data is fed to AES transmitters which format the 24 bit audio data according to the AES-3 standard.

NOTE: While it is possible to split the 8 (16) stereo AES outputs into 16 (32) mono channels, there are still only 8 (16) physical wires, each containing the 2-channel AES formatted data.

AES Output Interface

The balanced digital audio outputs on the DO-2016 card are transformer coupled and exhibit a nominal output impedance of 110 Ω . This interface operates at a nominal output voltage of +5V p-p and conforms to the AES-3 1992 electrical specification. The DO-2016 output cards operate at unity gain and transmit 24bit audio data word lengths at the system sample rate. Output sample rate is set to 44.1 kHz or 48 kHz via certain settings on the CPU-2001 card. Optionally, the CPU's *External AES Sync* input may be used to slave the system to a user, provided 44.1 kHz or 48 kHz reference rate. Please refer to the CPU-2001 hardware section for details on external synchronization.

The digital output signal reference level is -20dBFS. A +4dBu analog input signal yields a -20dBFS digital output signal. Channel Status implementation complies with rules for "standard implementation" as described in the AES-3 1992 specification.

AES Channel Status Implementation

The following embedded channel status information is transmitted at the AES digital outputs along with the audio data.

NOTE: Channel Status bits are identically set for channels 1 and 2.

CHANNEL STATUS:	PROFESSIONAL
DATA USE:	AUDIO (normal mode)
EMPHASIS:	NO EMPHASIS
SOURCE F _s LOCK:	LOCKED
SAMPLE FREQUENCY:	44.1kHz or 48kHz*
CHANNEL MODE:	STEREO
USER BITS MODE:	NONE
AUX BITS USE:	24 BIT - main audio
AUDIO WORD LENGTH:	24 BIT
REFERENCE SIGNAL:	NOT A REFERENCE SIGNAL
ORIGIN:	NOT INDICATED
DESTINATION:	NOT INDICATED
SAMPLE #:	∅
TIME OF DAY:	∅∅ : ∅∅ : ∅∅
BLOCK CRC:	IS VALID

* The Sample Rate frequency reported in the channel status block depends upon a dipswitch setting on the DO-2016 circuit board. DipSW2 - pos.3: OFF = 48 kHz, ON = 44.1 kHz.

NOTE: When changing the audio sample rate of the GIBALTAR Network System, changes must be made in the following places: DO-2016 Digital Output Card, CPU-2001 Host CPU, and QAT-2001 Quad Audio Network Card. See the appropriate manual sections for details. In addition, any Digital Control Surface in the system must be set for the same sample rate. See the Host CPU chapter of the surface manual for details.

Internal Programming Options

Internal programming is made via PCB mounted dipswitch SW2.

DO-2016 PCB SW2

POSITION	FUNCTION	ON	OFF
1	UNUSED	N/A	N/A
2	MONO SUM ENABLE	SUM	noSUM
3	CHANNEL STATUS F _s	44.1 kHz	48 kHz
4	CHANNEL STATUS IMPLEMENTATION	MINIMUM	STANDARD

NOTE: Mono Summing can only be enabled on the 8 output version of the card.

NOTE: Dipswitch SW2 position 3 sets the reported output sample rate frequency transmitted in a channel status block. This dipswitch does not change the physical sample rate.

Digital Output Card Status LED's



DONE LED (DS1) - Normally OFF;
ON when programming the FPGA,
Flashes when system clock is missing.

POWER SUPPLY STATUS (DS2, DS3) - ON indicates power
supply is OK.

JTAG HEADER - FPGA programming - factory use only.

AUXILIARY STATUS LED's

ACTIVITY LED (DS4) - Flashes on messages.

DS5 - Not Used

MUTE STATUS (DS6) - ON when the output channels are muted.

CFG STATUS (DS7) - ON when card is not configured.

Hook-Ups

All user wiring from the DO-2016 card takes place at the rear I/O connector modules: DB, 2DB, 8BNC, or 8RJ-45. The DB module has one female DB-25 connector and the 2DB has two DB-25 connectors for digital audio output connections. The 8BNC module contains eight BNC connectors for use with 75 ohm digital audio equipment. The 8RJ-45 module contains eight RJ-45 connectors for use in balanced, unshielded twisted pair (UTP) wiring systems.

DB-25 (for DO-2016/8) – Digital Audio Connections

These include eight outputs. Pinout drawing on page 2-31 shows all wiring connections at a glance.

Pin 24 – HI	}	AES 1 Out
Pin 12 – LO		
Pin 25 – SH		
Pin 10 – HI	}	AES 2 Out
Pin 23 – LO		
Pin 11 – SH		
Pin 21 – HI	}	AES 3 Out
Pin 9 – LO		
Pin 22 – SH		
Pin 7 – HI	}	AES 4 Out
Pin 20 – LO		
Pin 8 – SH		
Pin 18 – HI	}	AES 5 Out
Pin 6 – LO		
Pin 19 – SH		
Pin 4 – HI	}	AES 6 Out
Pin 17 – LO		
Pin 5 – SH		
Pin 15 – HI	}	AES 7 Out
Pin 3 – LO		
Pin 16 – SH		
Pin 1 – HI	}	AES 8 Out
Pin 14 – LO		
Pin 2 – SH		

2DB-25 (for DO-2016/16) – Digital Audio Connections

Upper DB-25 include eight (1-8) outputs. Pinout drawing on page 2-32 shows all wiring connections at a glance.

Pin 24 – HI	}	AES 1 Out
Pin 12 – LO		
Pin 25 – SH		
Pin 10 – HI	}	AES 2 Out
Pin 23 – LO		
Pin 11 – SH		

Pin 21 – HI]	AES 3 Out
Pin 9 – LO		
Pin 22 – SH		
Pin 7 – HI]	AES 4 Out
Pin 20 – LO		
Pin 8 – SH		
Pin 18 – HI]	AES 5 Out
Pin 6 – LO		
Pin 19 – SH		
Pin 4 – HI]	AES 6 Out
Pin 17 – LO		
Pin 5 – SH		
Pin 15 – HI]	AES 7 Out
Pin 3 – LO		
Pin 16 – SH		
Pin 1 – HI]	AES 8 Out
Pin 14 – LO		
Pin 2 – SH		

Lower DB-25 include eight (9-16) outputs. Pinout drawing on page 2-32 shows all wiring connections at a glance.

Pin 24 – HI]	AES 9 Out
Pin 12 – LO		
Pin 25 – SH		
Pin 10 – HI]	AES 10 Out
Pin 23 – LO		
Pin 11 – SH		
Pin 21 – HI]	AES 11 Out
Pin 9 – LO		
Pin 22 – SH		
Pin 7 – HI]	AES 12 Out
Pin 20 – LO		
Pin 8 – SH		
Pin 18 – HI]	AES 13 Out
Pin 6 – LO		
Pin 19 – SH		
Pin 4 – HI]	AES 14 Out
Pin 17 – LO		
Pin 5 – SH		
Pin 15 – HI]	AES 15 Out
Pin 3 – LO		
Pin 16 – SH		
Pin 1 – HI]	AES 16 Out
Pin 14 – LO		
Pin 2 – SH		

8BNC – Digital Audio Connections

This panel is used only for the DO-2016/8 card. Pinout drawing on page 2-33 shows all wiring connections at a glance.

BNC 1 Pin 1 – HI]	AES 1 Out
BNC 1 Pin 2 – SH		
BNC 2 Pin 1 – HI]	AES 2 Out
BNC 2 Pin 2 – SH		
BNC 3 Pin 1 – HI]	AES 3 Out
BNC 3 Pin 2 – SH		
BNC 4 Pin 1 – HI]	AES 4 Out
BNC 4 Pin 2 – SH		
BNC 5 Pin 1 – HI]	AES 5 Out
BNC 5 Pin 2 – SH		
BNC 6 Pin 1 – HI]	AES 6 Out
BNC 6 Pin 2 – SH		
BNC 7 Pin 1 – HI]	AES 7 Out
BNC 7 Pin 2 – SH		
BNC 8 Pin 1 – HI]	AES 8 Out
BNC 8 Pin 2 – SH		

8RJ-45 – Digital Audio Connections

For DO-2016/8 digital output connections use RJ-45 #1-4 connectors, and for DO-2016/16 use RJ-45 #1-8 connectors. Pinout drawing on page 2-34 shows all wiring connections at a glance.

RJ-45#1 Pin 1 – HI]	AES 1 Out
RJ-45#1 Pin 2 – LO		
RJ-45#1 Pin 3 – HI]	AES 2 Out
RJ-45#1 Pin 6 – LO		
RJ-45#2 Pin 1 – HI]	AES 3 Out
RJ-45#2 Pin 2 – LO		
RJ-45#2 Pin 3 – HI]	AES 4 Out
RJ-45#2 Pin 6 – LO		
RJ-45#3 Pin 1 – HI]	AES 5 Out
RJ-45#3 Pin 2 – LO		
RJ-45#3 Pin 3 – HI]	AES 6 Out
RJ-45#3 Pin 6 – LO		
RJ-45#4 Pin 1 – HI]	AES 7 Out
RJ-45#4 Pin 2 – LO		
RJ-45#4 Pin 3 – HI]	AES 8 Out
RJ-45#4 Pin 6 – LO		
RJ-45#5 Pin 1 – HI]	AES 9 Out
RJ-45#5 Pin 2 – LO		
RJ-45#5 Pin 3 – HI]	AES 10 Out
RJ-45#5 Pin 6 – LO		

RJ-45#6 Pin 1 – HI]	AES 11 Out
RJ-45#6 Pin 2 – LO		
RJ-45#6 Pin 3 – HI]	AES 12 Out
RJ-45#6 Pin 6 – LO		
RJ-45#7 Pin 1 – HI]	AES 13 Out
RJ-45#7 Pin 2 – LO		
RJ-45#7 Pin 3 – HI]	AES 14 Out
RJ-45#7 Pin 6 – LO		
RJ-45#8 Pin 1 – HI]	AES 15 Out
RJ-45#8 Pin 2 – LO		
RJ-45#8 Pin 3 – HI]	AES 16 Out
RJ-45#8 Pin 6 – LO		

DB Panel Digital Output Connections for DO-2016/8



“A” DB-25

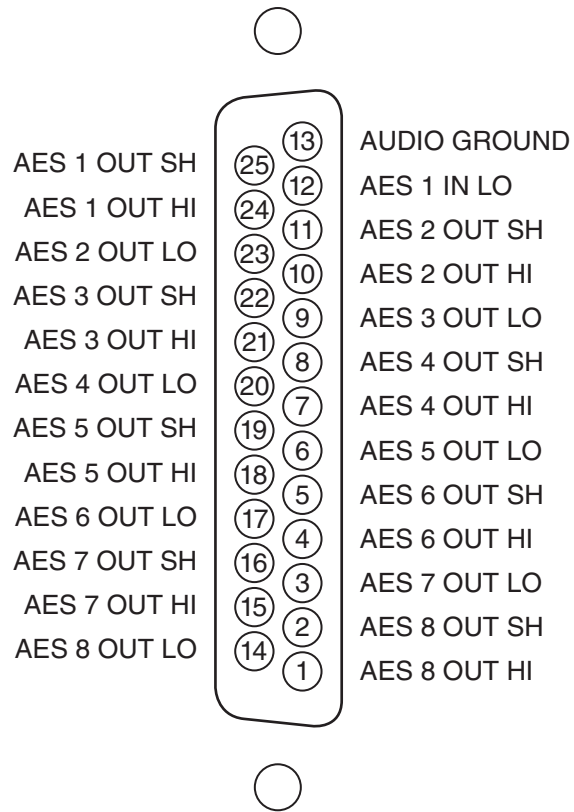

2DB Panel Digital Output Connections for DO-2016/16

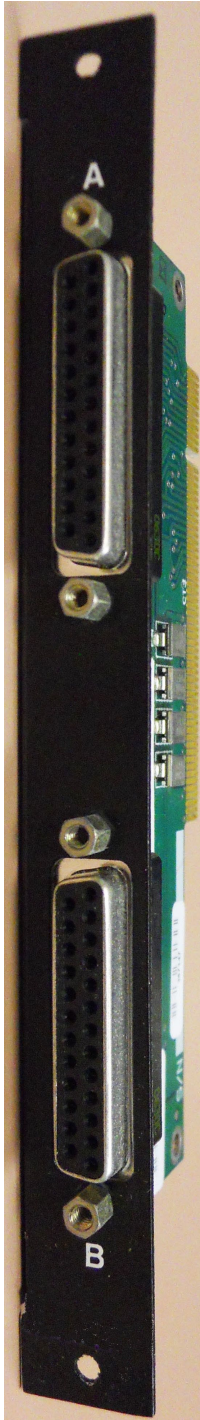

*Upper "A"
DB-25*

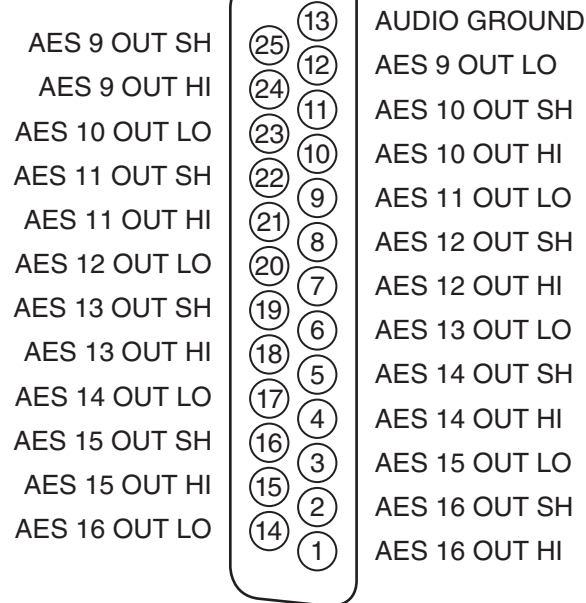
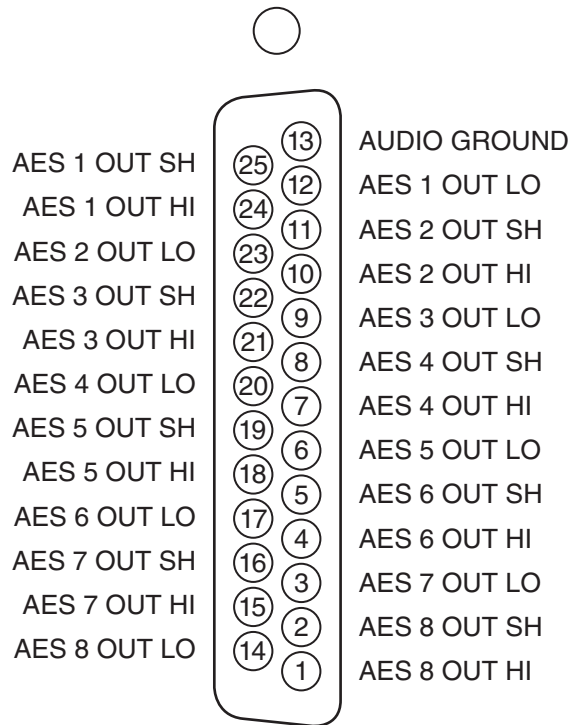

*Lower "B"
DB-25*

8BNC Panel Digital Output Connections for DO-2016/8

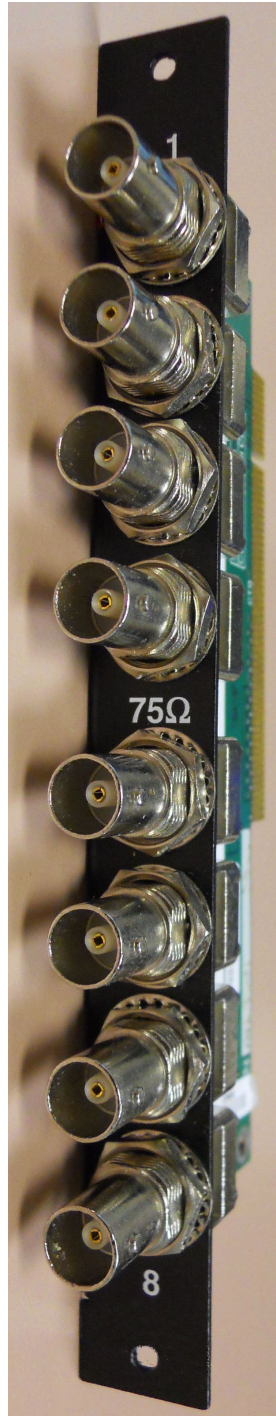

Use for 75 ohm AES-3 Id based systems

HI
SH AES 1 OUT

HI
SH AES 2 OUT

HI
SH AES 3 OUT

HI
SH AES 4 OUT

75Ω
HI
SH AES 5 OUT

HI
SH AES 6 OUT

HI
SH AES 7 OUT

HI
SH AES 8 OUT

8RJ Panel Digital Output Connections

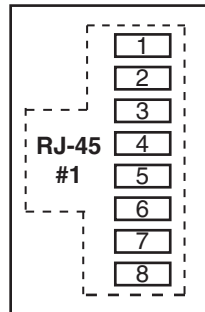
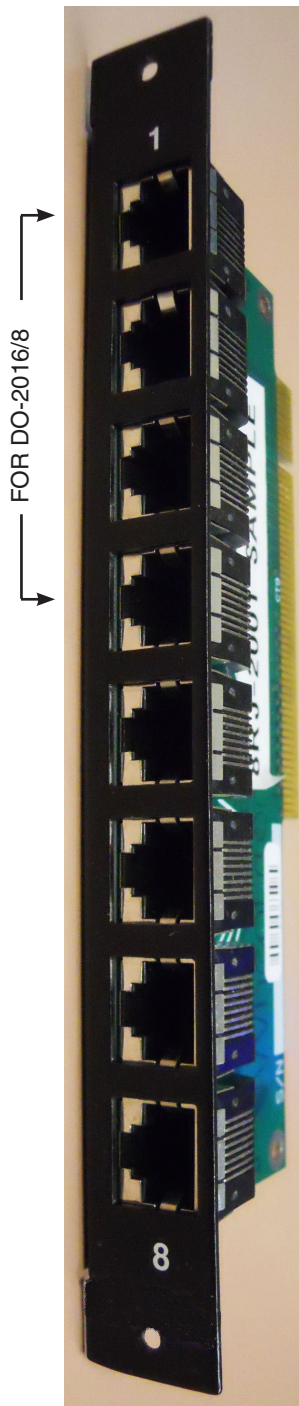

AES 1 OUT HI
AES 1 OUT LO
AES 2 OUT HI

AES 2 OUT LO

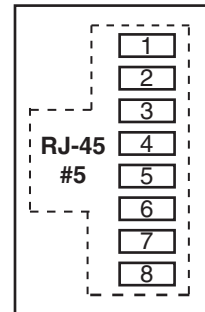

AES 9 OUT HI
AES 9 OUT LO
AES 10 OUT HI

AES 10 OUT LO

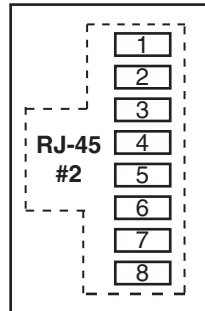

AES 3 OUT HI
AES 3 OUT LO
AES 4 OUT HI

AES 4 OUT LO

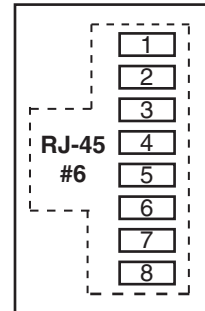

AES 11 OUT HI
AES 11 OUT LO
AES 12 OUT HI

AES 12 OUT LO

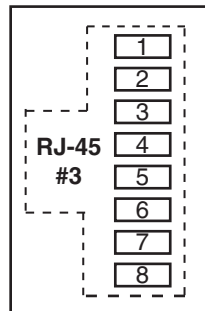

AES 5 OUT HI
AES 5 OUT LO
AES 6 OUT HI

AES 6 OUT LO

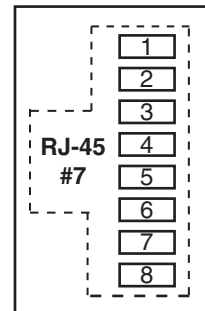

AES 13 OUT HI
AES 13 OUT LO
AES 14 OUT HI

AES 14 OUT LO

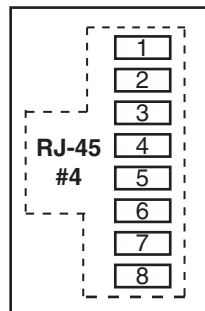

AES 7 OUT HI
AES 7 OUT LO
AES 8 OUT HI

AES 8 OUT LO

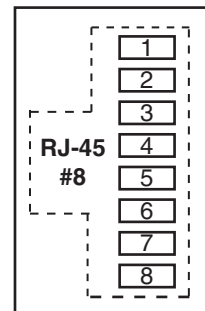

AES 15 OUT HI
AES 15 OUT LO
AES 16 OUT HI

AES 16 OUT LO

Analog Output Card (AO-2001)

Overview

Each Analog Output card provides 16 physical monaural *output channels*. These output channels are configured in software to be any combination of mono, stereo, or 5.1 *output signals*. A *Signal Definitions* form in the supplied XPoint software allows the user to set attributes for the output channels, including signal name, type, circuit #, etc. For example, the card may be configured as 8 stereo outputs, or 4 stereo outputs and 8 mono outputs. Many combinations are possible up to the card's 16 channel limit. Note that 5.1 signals may span across two AO-2001 output cards.

Each output card listens for connection commands from the CPU card and then uses this information to connect the appropriate sources to their selected output channels. The selected audio data is fed to 24 bit, two-channel digital-to-analog converters. The D-A converter outputs are buffered by integrated differential output drivers.

Analog Output Interface

Each balanced unity gain output will drive loads up to 600Ω and behaves much like a transformer in that either side of the balanced output may be grounded. The analog outputs are direct coupled with an output impedance of 50Ω and a nominal output signal level of +4dBu yielded from an analog input signal of +4dBu (-20dBFS digital).

Internal Programming Options

Internal programming is made via PCB mounted dipswitch SW1.

AO-2001PCB SW1

POSITION	FUNCTION	ON	OFF
1	UNUSED	N/A	N/A
2	MONO SUM ENABLE	SUM	noSUM
3	UNUSED	N/A	N/A
4	UNUSED	N/A	N/A

Analog Output Card Status LED's

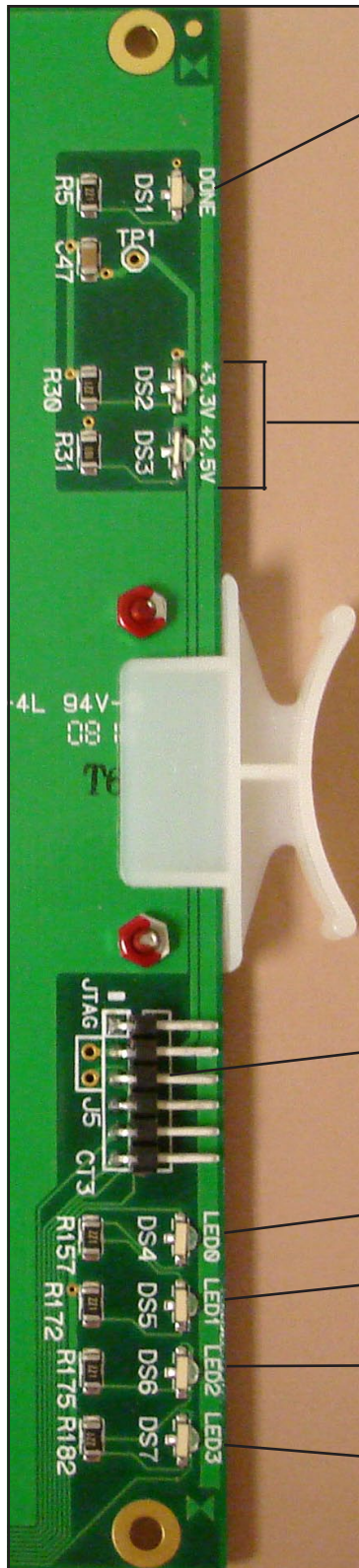

DONE LED (DS1) - Normally OFF;
ON when programming the FPGA,
Flashes when system clock is missing.

POWER SUPPLY STATUS (DS2,DS3) - ON indicates power
supply is OK.

JTAG HEADER - FPGA programming - factory use only.

AUXILIARY STATUS LED's

ACTIVITY LED (DS4) - Flashes on messages.

DS5 - Not Used

MUTE STATUS (DS6) - ON when the output channels
are muted.

CFG STATUS (DS7) - ON when card is not configured.

Hook-Ups

All user wiring from the AO-2001 card takes place at the rear I/O connector modules (2DB and 8RJ). The 2DB module has two DB-25 connectors and the 8RJ has eight RJ-45 connectors for audio output connections.

Upper DB-25 – Analog Audio Connections

These include four (1-4) outputs. Pinout drawing on page 2-39 shows all wiring connections at a glance.

Pin 24 – HI	}	Channel 1 (Stereo 1 Lt) Out
Pin 12 – LO		
Pin 25 – SH		
Pin 10 – HI	}	Channel 2 (Stereo 1 Rt) Out
Pin 23 – LO		
Pin 11 – SH		
Pin 21 – HI	}	Channel 3 (Stereo 2 Lt) Out
Pin 9 – LO		
Pin 22 – SH		
Pin 7 – HI	}	Channel 4 (Stereo 2 Rt) Out
Pin 20 – LO		
Pin 8 – SH		
Pin 18 – HI	}	Channel 5 (Stereo 3 Lt) Out
Pin 6 – LO		
Pin 19 – SH		
Pin 4 – HI	}	Channel 6 (Stereo 3 Rt) Out
Pin 17 – LO		
Pin 5 – SH		
Pin 15 – HI	}	Channel 7 (Stereo 4 Lt) Out
Pin 3 – LO		
Pin 16 – SH		
Pin 1 – HI	}	Channel 8 (Stereo 4 Rt) Out
Pin 14 – LO		
Pin 2 – SH		

Lower DB-25 – Analog Audio Connections

These include four (5-8) outputs. Pinout drawing on pages 2-39 shows all wiring connections at a glance.

Pin 24 – HI	}	Channel 9 (Stereo 5 Lt) Out
Pin 12 – LO		
Pin 25 – SH		
Pin 10 – HI	}	Channel 10 (Stereo 5 Rt) Out
Pin 23 – LO		
Pin 11 – SH		
Pin 21 – HI	}	Channel 11 (Stereo 6 Lt) Out
Pin 9 – LO		
Pin 22 – SH		

Pin 7 – HI	}	Channel 12 (Stereo 6 Rt) Out
Pin 20 – LO		
Pin 8 – SH		
Pin 18 – HI	}	Channel 13 (Stereo 7 Lt) Out
Pin 6 – LO		
Pin 19 – SH		
Pin 4 – HI	}	Channel 14 (Stereo 7 Rt) Out
Pin 17 – LO		
Pin 5 – SH		
Pin 15 – HI	}	Channel 15 (Stereo 8 Lt) Out
Pin 3 – LO		
Pin 16 – SH		
Pin 1 – HI	}	Channel 16 (Stereo 8 Rt) Out
Pin 14 – LO		
Pin 2 – SH		

8RJ-45 – Analog Audio Connections

Pinout drawing on pages 2-40 shows all wiring connections at a glance.

RJ-45#1 Pin 1 – HI	}	Channel 1 (Stereo 1 Lt) Out
RJ-45#1 Pin 2 – LO		
RJ-45#1 Pin 3 – HI	}	Channel 2 (Stereo 1 Rt) Out
RJ-45#1 Pin 6 – LO		
RJ-45#2 Pin 1 – HI	}	Channel 3 (Stereo 2 Lt) Out
RJ-45#2 Pin 2 – LO		
RJ-45#2 Pin 3 – HI	}	Channel 4 (Stereo 2 Rt) Out
RJ-45#2 Pin 6 – LO		
RJ-45#3 Pin 1 – HI	}	Channel 5 (Stereo 3 Lt) Out
RJ-45#3 Pin 2 – LO		
RJ-45#3 Pin 3 – HI	}	Channel 6 (Stereo 3 Rt) Out
RJ-45#3 Pin 6 – LO		
RJ-45#4 Pin 1 – HI	}	Channel 7 (Stereo 4 Lt) Out
RJ-45#4 Pin 2 – LO		
RJ-45#4 Pin 3 – HI	}	Channel 8 (Stereo 4 Rt) Out
RJ-45#4 Pin 6 – LO		
RJ-45#5 Pin 1 – HI	}	Channel 9 (Stereo 5 Lt) Out
RJ-45#5 Pin 2 – LO		
RJ-45#5 Pin 3 – HI	}	Channel 10 (Stereo 5 Rt) Out
RJ-45#5 Pin 6 – LO		
RJ-45#6 Pin 1 – HI	}	Channel 11 (Stereo 6 Lt) Out
RJ-45#6 Pin 2 – LO		
RJ-45#6 Pin 3 – HI	}	Channel 12 (Stereo 6 Rt) Out
RJ-45#6 Pin 6 – LO		
RJ-45#7 Pin 1 – HI	}	Channel 13 (Stereo 7 Lt) Out
RJ-45#7 Pin 2 – LO		
RJ-45#7 Pin 3 – HI	}	Channel 14 (Stereo 7 Rt) Out
RJ-45#7 Pin 6 – LO		
RJ-45#8 Pin 1 – HI	}	Channel 15 (Stereo 8 Lt) Out
RJ-45#8 Pin 2 – LO		
RJ-45#8 Pin 3 – HI	}	Channel 16 (Stereo 8 Rt) Out
RJ-45#8 Pin 6 – LO		

2DB Panel Analog Output Connections

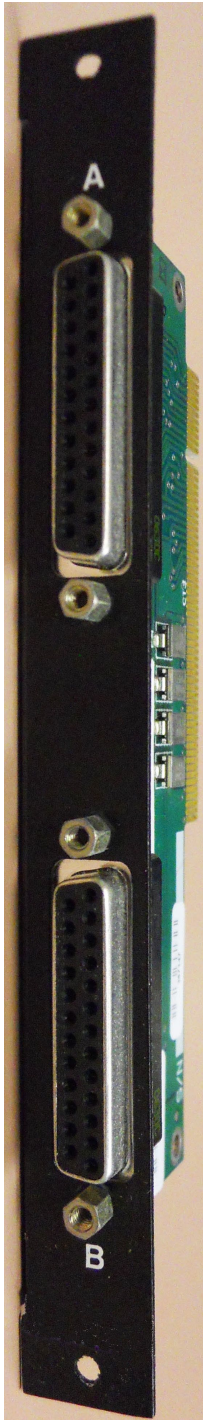

*Upper "A"
DB-25*

- CHANNEL 1 (STEREO 1 LT) OUT SH
- CHANNEL 1 (STEREO 1 LT) OUT HI
- CHANNEL 2 (STEREO 1 RT) OUT LO
- CHANNEL 3 (STEREO 2 LT) OUT SH
- CHANNEL 3 (STEREO 2 LT) OUT HI
- CHANNEL 4 (STEREO 2 RT) OUT LO
- CHANNEL 5 (STEREO 3 LT) OUT SH
- CHANNEL 5 (STEREO 3 LT) OUT HI
- CHANNEL 6 (STEREO 3 RT) OUT LO
- CHANNEL 7 (STEREO 4 LT) OUT SH
- CHANNEL 7 (STEREO 4 LT) OUT HI
- CHANNEL 8 (STEREO 4 RT) OUT LO

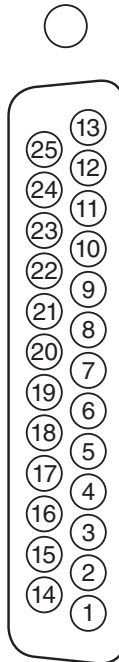

- AUDIO GROUND
- CHANNEL 1 (STEREO 1 LT) OUT LO
- CHANNEL 2 (STEREO 1 RT) OUT SH
- CHANNEL 2 (STEREO 1 RT) OUT HI
- CHANNEL 3 (STEREO 2 LT) OUT LO
- CHANNEL 4 (STEREO 2 RT) OUT SH
- CHANNEL 4 (STEREO 2 RT) OUT HI
- CHANNEL 5 (STEREO 3 LT) OUT LO
- CHANNEL 6 (STEREO 3 RT) OUT SH
- CHANNEL 6 (STEREO 3 RT) OUT HI
- CHANNEL 7 (STEREO 4 LT) OUT LO
- CHANNEL 8 (STEREO 4 RT) OUT SH
- CHANNEL 8 (STEREO 4 RT) OUT HI

- CHANNEL 9 (STEREO 5 LT) OUT SH
- CHANNEL 9 (STEREO 5 LT) OUT HI
- CHANNEL 10 (STEREO 5 RT) OUT LO
- CHANNEL 11 (STEREO 6 LT) OUT SH
- CHANNEL 11 (STEREO 6 LT) OUT HI
- CHANNEL 12 (STEREO 6 RT) OUT LO
- CHANNEL 13 (STEREO 7 LT) OUT SH
- CHANNEL 13 (STEREO 7 LT) OUT HI
- CHANNEL 14 (STEREO 7 RT) OUT LO
- CHANNEL 15 (STEREO 8 LT) OUT SH
- CHANNEL 15 (STEREO 8 LT) OUT HI
- CHANNEL 16 (STEREO 8 RT) OUT LO

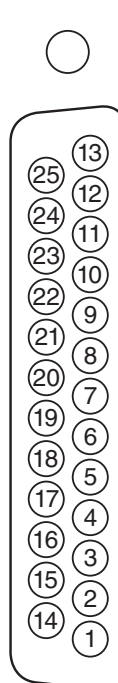

- AUDIO GROUND
- CHANNEL 9 (STEREO 5 LT) OUT LO
- CHANNEL 10 (STEREO 5 RT) OUT SH
- CHANNEL 10 (STEREO 5 RT) OUT HI
- CHANNEL 11 (STEREO 6 LT) OUT LO
- CHANNEL 12 (STEREO 6 RT) OUT SH
- CHANNEL 12 (STEREO 6 RT) OUT HI
- CHANNEL 13 (STEREO 7 LT) OUT LO
- CHANNEL 14 (STEREO 7 RT) OUT SH
- CHANNEL 14 (STEREO 7 RT) OUT HI
- CHANNEL 15 (STEREO 8 LT) OUT LO
- CHANNEL 16 (STEREO 8 RT) OUT SH
- CHANNEL 16 (STEREO 8 RT) OUT HI

*Lower "B"
DB-25*

8RJ Panel Analog Output Connections

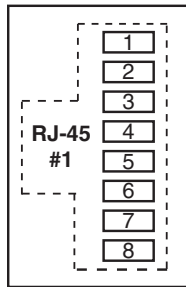

CHANNEL 1 (STEREO 1 LT) OUT HI
CHANNEL 1 (STEREO 1 LT) OUT LO
CHANNEL 2 (STEREO 1 RT) OUT HI
CHANNEL 2 (STEREO 1 RT) OUT LO

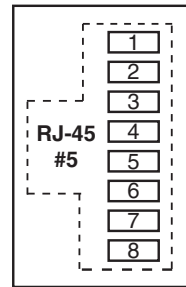

CHANNEL 9 (STEREO 5 LT) OUT HI
CHANNEL 9 (STEREO 5 LT) OUT LO
CHANNEL 10 (STEREO 5 RT) OUT HI
CHANNEL 10 (STEREO 5 RT) OUT LO

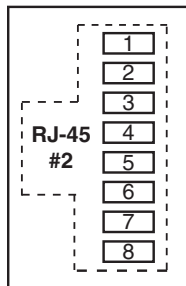

CHANNEL 3 (STEREO 2 LT) OUT HI
CHANNEL 3 (STEREO 2 LT) OUT LO
CHANNEL 4 (STEREO 2 RT) OUT HI
CHANNEL 4 (STEREO 2 RT) OUT LO

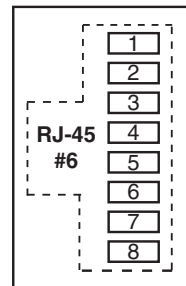

CHANNEL 11 (STEREO 6 LT) OUT HI
CHANNEL 11 (STEREO 6 LT) OUT LO
CHANNEL 12 (STEREO 6 RT) OUT HI
CHANNEL 12 (STEREO 6 RT) OUT LO

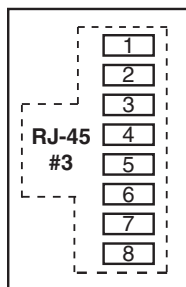

CHANNEL 5 (STEREO 3 LT) OUT HI
CHANNEL 5 (STEREO 3 LT) OUT LO
CHANNEL 6 (STEREO 3 RT) OUT HI
CHANNEL 6 (STEREO 3 RT) OUT LO

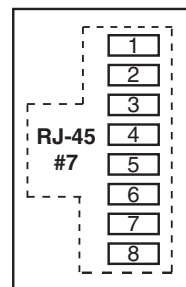

CHANNEL 13 (STEREO 7 LT) OUT HI
CHANNEL 13 (STEREO 7 LT) OUT LO
CHANNEL 14 (STEREO 7 RT) OUT HI
CHANNEL 14 (STEREO 7 RT) OUT LO

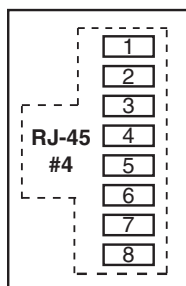

CHANNEL 7 (STEREO 4 LT) OUT HI
CHANNEL 7 (STEREO 4 LT) OUT LO
CHANNEL 8 (STEREO 4 RT) OUT HI
CHANNEL 8 (STEREO 4 RT) OUT LO

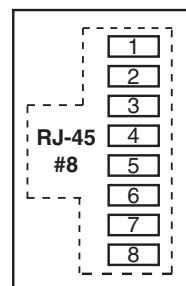

CHANNEL 15 (STEREO 8 LT) OUT HI
CHANNEL 15 (STEREO 8 LT) OUT LO
CHANNEL 16 (STEREO 8 RT) OUT HI
CHANNEL 16 (STEREO 8 RT) OUT LO

Microphone Card (MIC-2001)

Overview

The Microphone input/output card accepts 8 mono microphone input audio sources and provides 8 mono direct output channels. A *Signal Definitions* form in the supplied XPoint software allows the user to set attributes for the input and output channels, including signal name, type, circuit #, etc.

The balanced, mic level input signals are amplified by a remote controlled dual stage preamplifier. Each preamplified microphone signal is fed to a balanced, line level direct output. The preamplified microphone signal is also converted to the digital domain by 24bit A-D converters operating at the system's master sample rate. Embedded logic routes each channel of audio data into an available time slot of the card's TDM bus. One TDM bus is allocated for each card.

Analog Input Interface

The MIC-2001 uses an electronically balanced, monolithic preamplifier capable of a wide range of input signals. While all microphone inputs employ high frequency filtering components, be sure to install a high quality microphone cable to help eliminate unwanted EMI and RFI artifacts.

Preamp specifications:

Nominal Mic Level = - 50dBm (2mV RMS), 150 ohms

Max input level = -10dBu

Headroom = 20dB

Gain Range = +20 to +80dB

Phantom Power = 32V

Direct Output Level = 10dB steps

Internal Programming Options

There are no internal programming options on the MIC-2001 card.

Microphone Card Status LED's

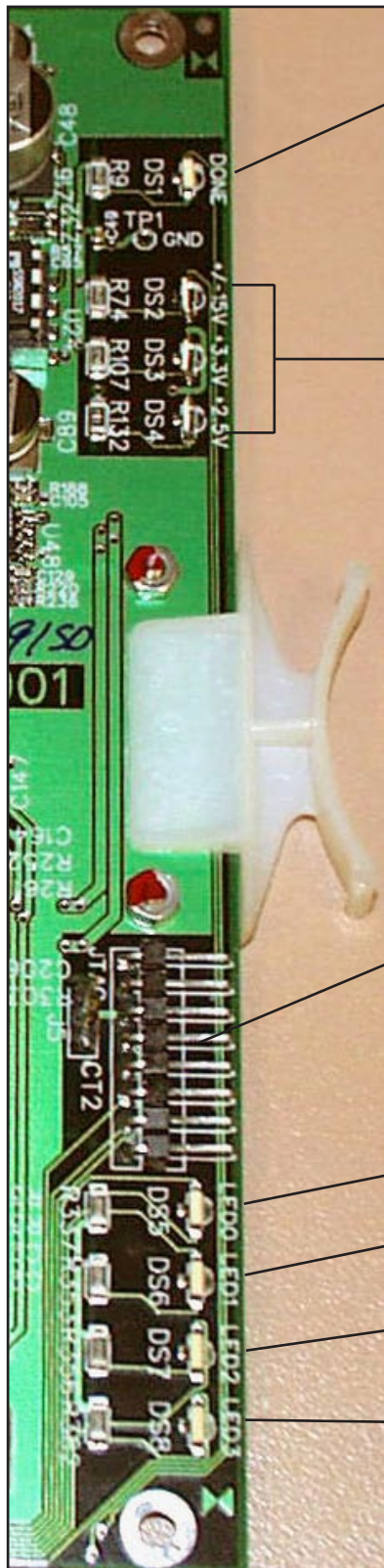

DONE LED (DS1) - Normally OFF;
ON when programming the FPGA,
Flashes when system clock is missing.

POWER SUPPLY STATUS (DS2-DS4) - ON indicates power
supply is OK.

JTAG HEADER - FPGA programming - factory use only.

AUXILIARY STATUS LED's

ACTIVITY LED (DS5) - Flashes on messages.

DS6 - Not Used

MUTE STATUS (DS7) - ON when the input channels
are muted.

CFG STATUS (DS8) - ON when card is not configured.

Hook-Ups

All user wiring to the MIC-2001 card takes place at the rear I/O connector modules: 2DB or 8RJ-45. The 2DB module has two female DB-25 connectors for audio input/output connections. The 8RJ-45 module contains eight RJ-45 connectors for use in balanced, unshielded twisted pair (UTP) wiring systems.

Upper DB-25 – Analog Audio Input Connections

These include eight mic input sources. Pinout drawing on page 2-45 shows all wiring connections at a glance.

Pin 24 – HI	}	Mic 1 In
Pin 12 – LO		
Pin 25 – SH		
Pin 10 – HI	}	Mic 2 In
Pin 23 – LO		
Pin 11 – SH		
Pin 21 – HI	}	Mic 3 In
Pin 9 – LO		
Pin 22 – SH		
Pin 7 – HI	}	Mic 4 In
Pin 20 – LO		
Pin 8 – SH		
Pin 18 – HI	}	Mic 5 In
Pin 6 – LO		
Pin 19 – SH		
Pin 4 – HI	}	Mic 6 In
Pin 17 – LO		
Pin 5 – SH		
Pin 15 – HI	}	Mic 7 In
Pin 3 – LO		
Pin 16 – SH		
Pin 1 – HI	}	Mic 8 In
Pin 14 – LO		
Pin 2 – SH		

Lower DB-25 – Analog Audio Output Connections

These include eight direct outputs. Pinout drawing on page 2-45 shows all wiring connections at a glance.

Pin 24 – HI	}	Direct 1 Out
Pin 12 – LO		
Pin 25 – SH		
Pin 10 – HI	}	Direct 2 Out
Pin 23 – LO		
Pin 11 – SH		
Pin 21 – HI	}	Direct 3 Out
Pin 9 – LO		
Pin 22 – SH		

Pin 7 – HI	}	Direct 4 Out
Pin 20 – LO		
Pin 8 – SH		
Pin 18 – HI	}	Direct 5 Out
Pin 6 – LO		
Pin 19 – SH		
Pin 4 – HI	}	Direct 6 Out
Pin 17 – LO		
Pin 5 – SH		
Pin 15 – HI	}	Direct 7 Out
Pin 3 – LO		
Pin 16 – SH		
Pin 1 – HI	}	Direct 8 Out
Pin 14 – LO		
Pin 2 – SH		

8RJ-45 – Analog Audio Connections

For analog input connections use connectors 1-4, and for direct output use connectors 5-8. Pinout drawing on page 2-46 shows all wiring connections at a glance.

RJ-45#1 Pin 3 – HI	}	Mic 1 In
RJ-45#1 Pin 6 – LO		
RJ-45#1 Pin 1 – HI	}	Mic 2 In
RJ-45#1 Pin 2 – LO		
RJ-45#2 Pin 3 – HI	}	Mic 3 In
RJ-45#2 Pin 6 – LO		
RJ-45#2 Pin 1 – HI	}	Mic 4 In
RJ-45#2 Pin 2 – LO		
RJ-45#3 Pin 3 – HI	}	Mic 5 In
RJ-45#3 Pin 6 – LO		
RJ-45#3 Pin 1 – HI	}	Mic 6 In
RJ-45#3 Pin 2 – LO		
RJ-45#4 Pin 3 – HI	}	Mic 7 In
RJ-45#4 Pin 6 – LO		
RJ-45#4 Pin 1 – HI	}	Mic 8 In
RJ-45#4 Pin 2 – LO		
RJ-45#5 Pin 3 – HI	}	Direct 1 Out
RJ-45#5 Pin 6 – LO		
RJ-45#5 Pin 1 – HI	}	Direct 2 Out
RJ-45#5 Pin 2 – LO		
RJ-45#6 Pin 3 – HI	}	Direct 3 Out
RJ-45#6 Pin 6 – LO		
RJ-45#6 Pin 1 – HI	}	Direct 4 Out
RJ-45#6 Pin 2 – LO		
RJ-45#7 Pin 3 – HI	}	Direct 5 Out
RJ-45#7 Pin 6 – LO		
RJ-45#7 Pin 1 – HI	}	Direct 6 Out
RJ-45#7 Pin 2 – LO		
RJ-45#8 Pin 3 – HI	}	Direct 7 Out
RJ-45#8 Pin 6 – LO		
RJ-45#8 Pin 1 – HI	}	Direct 8 Out
RJ-45#8 Pin 2 – LO		

2DB Panel

Mic Analog Input/Output Connections

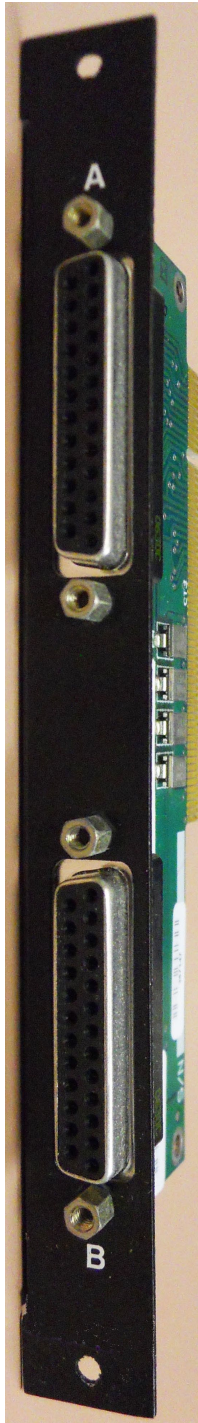

*Upper "A"
DB-25*

MIC 1 IN SH	(25)	(13)	AUDIO GROUND
MIC 1 IN HI	(24)	(12)	MIC 1 IN LO
MIC 2 IN LO	(23)	(11)	MIC 2 IN SH
MIC 2 IN HI	(22)	(10)	MIC 2 IN LO
MIC 3 IN SH	(21)	(9)	MIC 3 IN HI
MIC 3 IN LO	(20)	(8)	MIC 3 IN LO
MIC 4 IN HI	(19)	(7)	MIC 4 IN SH
MIC 4 IN LO	(18)	(6)	MIC 4 IN HI
MIC 5 IN SH	(17)	(5)	MIC 5 IN LO
MIC 5 IN HI	(16)	(4)	MIC 6 IN SH
MIC 6 IN LO	(15)	(3)	MIC 6 IN HI
MIC 6 IN HI	(14)	(2)	MIC 7 IN LO
MIC 7 IN SH	(13)	(1)	MIC 8 IN SH
MIC 7 IN LO			MIC 8 IN HI

DIRECT 1 OUT SH	(25)	(13)	AUDIO GROUND
DIRECT 1 OUT HI	(24)	(12)	DIRECT 1 OUT IN LO
DIRECT 2 OUT LO	(23)	(11)	DIRECT 2 OUT SH
DIRECT 2 OUT SH	(22)	(10)	DIRECT 2 OUT HI
DIRECT 3 OUT HI	(21)	(9)	DIRECT 3 OUT LO
DIRECT 3 OUT LO	(20)	(8)	DIRECT 4 OUT SH
DIRECT 4 OUT SH	(19)	(7)	DIRECT 4 OUT HI
DIRECT 4 OUT HI	(18)	(6)	DIRECT 5 OUT LO
DIRECT 5 OUT LO	(17)	(5)	DIRECT 6 OUT SH
DIRECT 5 OUT SH	(16)	(4)	DIRECT 6 OUT HI
DIRECT 6 OUT HI	(15)	(3)	DIRECT 7 OUT LO
DIRECT 6 OUT LO	(14)	(2)	DIRECT 8 OUT SH
DIRECT 7 OUT SH	(13)	(1)	DIRECT 8 OUT HI
DIRECT 7 OUT LO			
DIRECT 8 OUT HI			

*Lower "B"
DB-25*

8RJ Panel Mic Analog Input/Output Connections

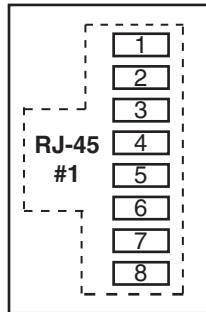
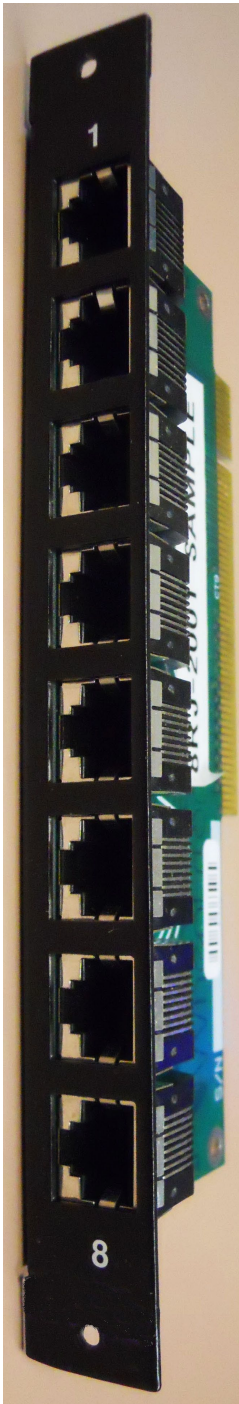

MIC 1 IN HI
MIC 1 IN LO
MIC 2 IN HI

MIC 2 IN LO

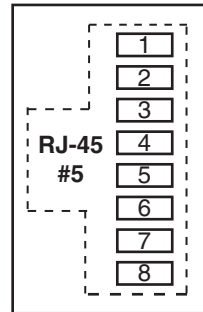

DIRECT 2 OUT HI
DIRECT 2 OUT LO
DIRECT 1 OUT HI

DIRECT 1 OUT LO

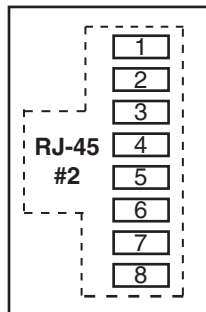

MIC 3 IN HI
MIC 3 IN LO
MIC 4 IN HI

MIC 4 IN LO

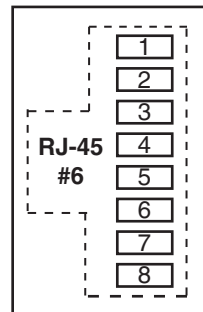

DIRECT 4 OUT HI
DIRECT 4 OUT LO
DIRECT 3 OUT HI

DIRECT 3 OUT LO

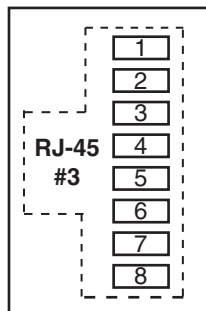

MIC 5 IN HI
MIC 5 IN LO
MIC 6 IN HI

MIC 6 IN LO

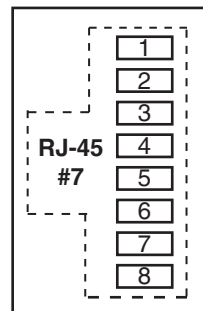

DIRECT 6 OUT HI
DIRECT 6 OUT LO
DIRECT 5 OUT HI

DIRECT 5 OUT LO

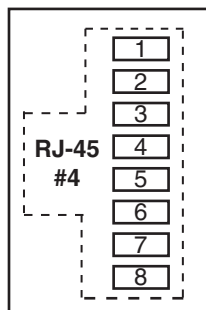

MIC 7 IN HI
MIC 7 IN LO
MIC 8 IN HI

MIC 8 IN LO

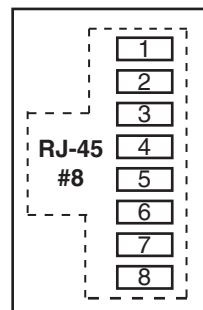

DIRECT 8 OUT HI
DIRECT 8 OUT LO
DIRECT 7 OUT HI

DIRECT 7 OUT LO

Host CPU (CPU-2001)

Overview

The host CPU card used in the GIBALTAR NETWORK incorporates a PC/104 computer mounted on a backplane interface card (the HC-2001 PCB). The host computer utilizes RAM, a flash disk (which emulates a standard IDE hard drive), and an Ethernet port. There is no hard disk drive. Keyboard, floppy controller, and video ports are for factory use only. The host CPU board must only be present in the “master chassis” of a single tier switch.

The purpose of the CPU card is to provide control of the GIBALTAR NETWORK system, including the master chassis and any other chassis connected via Audio Network card. The CPU communicates to the XPoint Configuration PC and XY Controllers via TCP/IP over Ethernet, via a backplane command bus to the other cards in its switch, and via RS-485 serial links to existing XY Controllers and Wheatstone consoles. The CPU also phase locks the crosspoint switch and attached remote racks to an on-board crystal oscillator or an external AES “black” reference source.

Hardware and software configuration, as well as real time crosspoint information, is saved in non-volatile storage on the CPU card and is restored at power up or reset. This configuration information provides details to the host application running on the CPU such as the specific audio hardware available, serial port allocation, I/O signal names, etc., and may be modified via the XPoint Configuration GUI. Switching information is dynamically controlled via both hardware based XY Controllers and software based XY controllers. An integral FTP server provides access to the files on the Host CPU’s flash disk drive from any FTP client. Network IP address configuration is stored in a text file on the CPU and may be edited in any text editor. See Appendix 1 for details.

Multi CPU/Failover CPU Systems

Multiple CPU’s may optionally be present in large “Multi-Tier” configurations. For the sake of clarity, a single CPU system is assumed in this discussion. Please consult the factory for multi-cpu system details. See Appendix 2 for details on failover CPU operation.

CPU-2001 BIOS Settings/Format

BIOS Setup and formatting of the Host CPU is completed prior to the testing of your GIBALTAR at the Wheatstone factory. There are no user adjustable settings. Please contact customer support with questions regarding the PC/104 SBC BIOS settings or flash disk formatting.

Ethernet IP Addressing

Wheatstone GIBRALTAR NETWORK digital audio network routers ship with the host CPU IP address set for 192.168.1.160 and the personal computer's NIC (if a computer is supplied with the system) set for 192.168.1.212. Stand-alone systems (not interfaced to a station's existing network) require no IP address changes.

The actual network settings are stored in a text file on each GIBRALTAR CPU. The file name is XP_NET.txt, and the file lives in the root directory of the CPU's flash disk drive. To change network settings, you must FTP to the CPU, download the file, edit as required, and then upload back to the CPU. Note that systems with Redundant and or Tier CPU's, must also have their XP_NET.txt files edited. See the "*Gibraltar/Ethernet IP Address Quick Start*" guide at the beginning of Chapter 4 for detailed information. The file editing process is explained in Appendix 1 of this manual.

Ethernet Interface Wiring

Stand-alone systems are defined as a host rack connected to an XPoint configuration PC and not interfaced to a station's existing network. Stand-alone systems are "point to point" configurations and are connected by a CAT-5 crossover cable.

Networked systems are defined as a host rack connected directly to an existing Ethernet network hub. Networked systems are connected to the network hub via a straight (pin to pin) CAT-5 cable. Typical CAT-5 cable pinouts are included in the *Hook-Ups* section near the end of this chapter.

Internal Programming Options

All internal programming options are made via PCB mounted dipswitches and jumpers. These settings are summarized in the table below:

CPU (HC-2001PCB)

NAME	REF.DES.	DEFAULT
RACK-ID	SW7	0000 (ALL OFF)
48H_44.1L	J6	OPEN (48 kHz)
AUTODETECT	SW8 pos.1	ON
CPU_RESET	SW5	OPEN
MSR_SELECT	SW9	OPEN
485_A_TERM	SW1, SW2	BIAS TERMINATION
485_B_TERM	SW3, SW4	BIAS TERMINATION
RS-232 GND	J1	OPEN for 485
AGND to DGND	J4	OPEN

Switch Settings

DIPSW1-SW4 RS-485 Termination

These four 4-position dipswitches configure the 485 port termination as follows:

SW1 - SW4

POSITION	FUNCTION	BIASED TERM	PASSIVE TERM	UNTERMINATED
1 - TX10Ω	ON=10Ω BYPASS	OFF*	ON	OFF
2 - TX+	ON=750Ω PULLUP	ON*	OFF	OFF
3 - TX-	ON=750Ω PULLDOWN	ON*	OFF	OFF
4 - 120Ω	ON=120Ω PARALLEL	ON*	ON	OFF

Choices are Unterminated, Normal Termination, or BIAS Termination on the transmit and receive lines. SW1 and SW2 are for Port A, and SW3 and SW4 are for Port B. SW1 and SW3 are for the RS-485 transmitter's termination on the CPU; SW2 and SW4 are for receiver terminations.

An RS-485 bus may only be BIAS TERMINATED at one end. All applicable QAT and CPU cards are set for BIAS TERMINATION by default. All peripheral devices are set for NO TERMINATION by default. Set the TERMINATION to ON for the last controller or console only, in an RS-485 chain.

SW5 - CPU Reset

This momentary pushbutton switch allows the CPU to be reset without powering down the system. Holding the button for two seconds will also cause the FPGA program to be reloaded, and will reset the crosspoints on that tier.

DIPSW6 - Utility Switches

Pos.1 - DIP4 - Not Used

Pos.2 - DIP5 - Not Used

Pos.3 - C6 - Not Used

Pos.4 - C7 - Not Used

DIPSW7 - Rack ID

NOTE: Rack ID numbers are coded in binary.

Default is all OFF (Rack ID 1, binary 0000) for a master rack CPU.

Rack ID 1 equals binary 0, Rack ID 2 equals binary 1, etc.

Rack ID's are set at the factory. Incorrect setting of these switches can cause system malfunction.

DIPSW8

Pos.1 - Autodetect - Default is OFF

Autodetect will sense the presence of an external AES input clock and slave the system to this AES reference. If the AES reference fails (wire breaks, etc.) the system will revert

to the onboard crystal reference until the AES input returns. Autodetect disabled forces the system to ignore the AES reference and always use the onboard crystal. LED1-DS8 will light if Autodetect is enabled, and sync is lost.

Pos.2 - Not Used

Pos.3 - Not Used

Pos.4 - Not Used

SW9 - Master Select

This momentary pushbutton switch may be used to force a failover from one CPU to the other in a dual CPU system. Press this switch on the *current* ONLINE CPU to force failover. LED3-DS11 indicates which CPU is ONLINE. You can also check “AdvXP Status” in XPoint to confirm a CPU’s ONLINE/OFFLINE status.

Jumper Settings

J1 - RS-232 GND - Default is “OPEN”

J1 is inserted if Port A is to be used as an RS-232 port rather than RS-485. The jumper shorts DB-9 connector Pin 8 to ground for use as the RS-232 ground reference.

J2 - Not Used

J3 - Not Used

J4 - AGND to DGND - Default is “OPEN”

J4 connects Audio Ground to Digital Ground.

J5 - FPGA PGM - Momentary shorting will reload the FPGA program.

J6 - 48 or 44.1kHz Sample Rate Select*

Selects 48kHz or 44.1kHz as the Master Fs frequency, derived from the onboard crystal oscillators.

J6 open - 48 kHz

J6 shunted - 44.1 kHz

*NOTE: When changing the audio sample rate of the GIBALTAR NETWORK System, changes must be made in the following places: DO-2016 Digital Output Card, CPU-2001 Host CPU, and QAT-2001 Quad Audio Network Card. See the appropriate manual sections for details. In addition, any Digital Control Surface in the system must be set for the same sample rate. See the Host CPU chapter of the surface manual for details.

CPU Card Status LED's

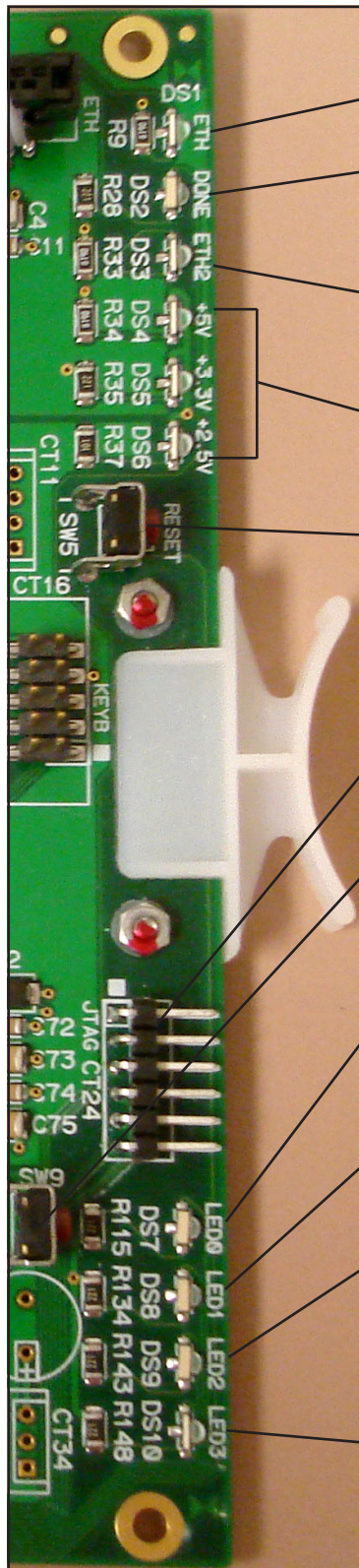

- ETHERNET LINK (DS1) - ON indicates Ethernet is link OK.
- DONE LED (DS2) - Normally OFF; ON when programming the FPGA, Flashes when system clock is missing.
- ETHERNET ACTIVITY (DS3) - ON indicates TCP/IP activity.
- POWER SUPPLY STATUS (DS4-DS6) - ON indicates power supply is OK.
- RESET SWITCH (SW5) - Momentary pushbutton. Hold for 2 seconds for complete reset of CPU and FPGA. Quick TAP for soft reboot.
- JTAG HEADER - FPGA programming - factory use only.
- MASTER SELECT (SW9) - Force CPU Failover. Press SW9 on the current Online CPU to failover to opposite CPU.
- BACKPLANE RESPONSE (DS7) - Lights if the CPU is not responding to backplane messages.
- CLOCK PHASE (DS8) - ON indicates an EXT AES Sync problem.
- BUFFER ACTIVITY (DS9) - Always ON on an OFFLINE Tier1 CPU. Flashes during file transfer with XPoint. Normally OFF on any OFFLINE CPU, not in Tier 1.
- CLOCK MASTER (DS10) - ON indicates CPU is driving backplane clock. Normally OFF on OFFLINE CPU's.

Hook-Ups

All user wiring to and from the CPU card takes place at the HCI-2001 rear I/O connector module.

There are pair of 75 ohm BNC connectors to provide a DARS reference input (per AES-11) to sync to the house DARS reference and an output to provide DARS reference.

There is one RJ-45 jack for the CPU Ethernet connection.

Pinout drawing on page 2-54 shows all wiring connections at a glance.

“IN” and “OUT” BNC – DARS Connections

BNC IN Pin 1 – HI]	DARS In
BNC IN Pin 2 – SH		
BNC OUT Pin 1 – HI]	DARS Out
BNC OUT Pin 2 – SH		

RJ-45 – Ethernet Connections

Pin 1 – TXD +
 Pin 2 – TXD -
 Pin 3 – RXD +
 Pin 4 – N/C
 Pin 5 – N/C
 Pin 6 – RXD -
 Pin 7 – LN LED
 Pin 8 – LK LED

Typical Straight-Through Cable

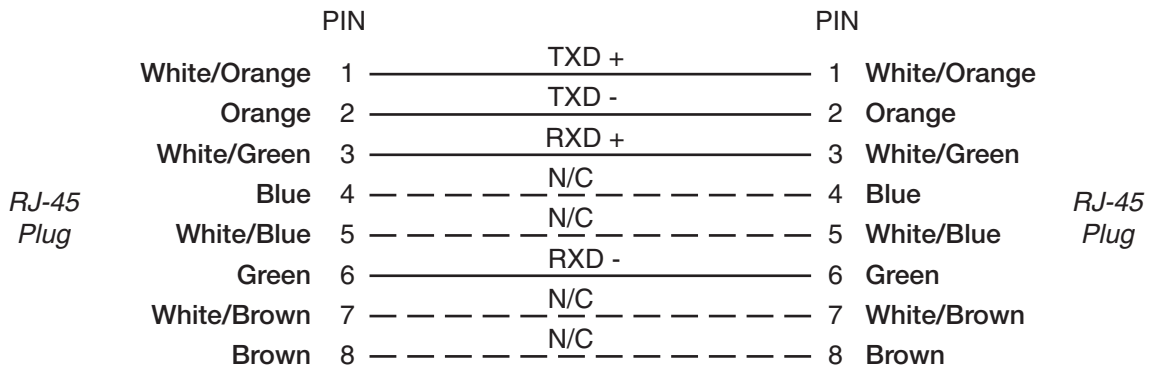

Used for connecting the Host CPU module to your network hub.

Typical Crossover Cable

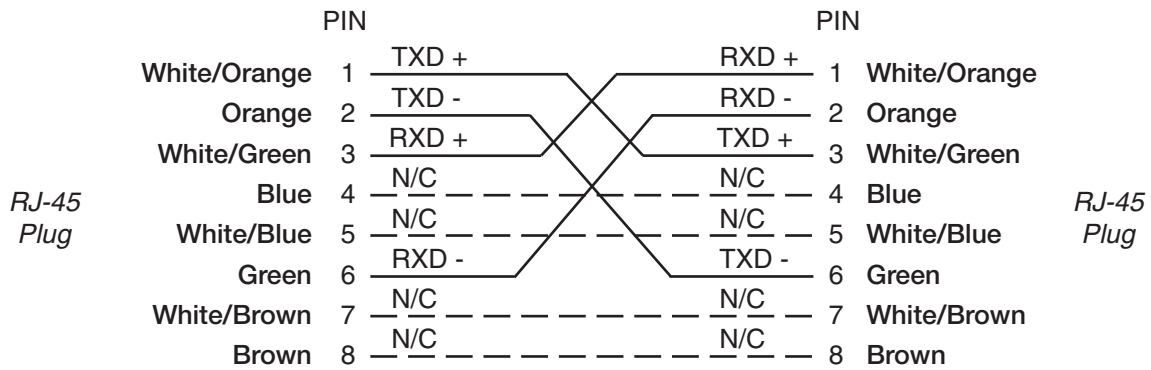

Used for point to point connections between the Wheatstone AT and MT ports, such as connections between tier racks and the connection between a surface and its tier rack.

HCI Panel Input/Output Connections



DARS - 75 ohm BNC

PIN 1 - HI DARS IN
PIN 2 - SH

PIN 1 - HI DARS OUT
PIN 2 - SH

ETHERNET

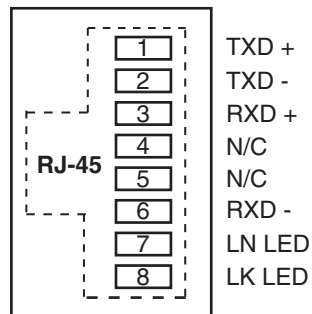

Legacy HCI Panel Input/Output Connections

SERIAL A-B-C PORTS



Left "A" DB-9

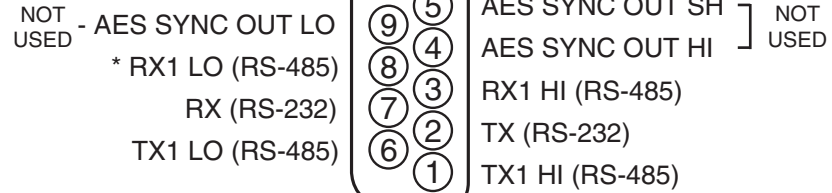

* This pin is RS-232 GND when J1 is installed on CPU

Right "B" DB-9

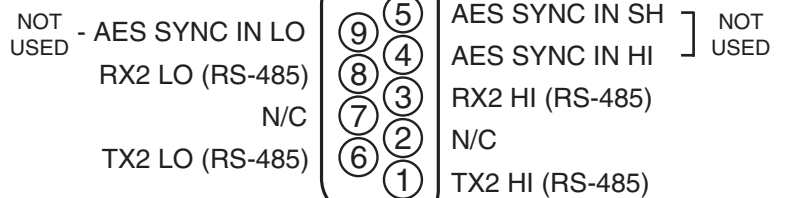

Lower "C" DB-9

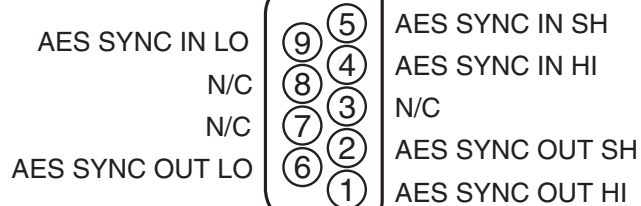

ETHERNET

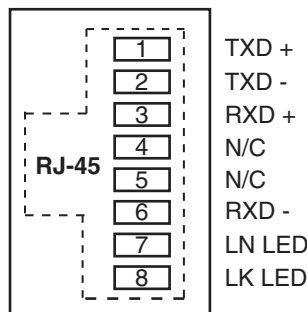

Quad Audio Network Card (QAT-2001)

Overview

The Quad Audio Network card provides a robust and deterministic link between multiple audio racks or control surfaces via fiber optic or CAT-5 cable. The 4 ports, A, B, C, & D, may be independently configured in hardware for either audio or control surface connections. Ports configured for Audio Transport are called “AT” links, while ports configured for control surface use are called “MT” or Mixer Transport links. Wheatstone’s XPoint software is used to map the QAT ports to specific control surfaces and audio racks.

In a Multi-Tiered system, QAT cards are used as the “spoke” connections between the Hub switch and up to 14 Remote Tiers. Control surfaces and satellite cages may then be connected to the master racks of the remote Tiers through additional QAT cards.

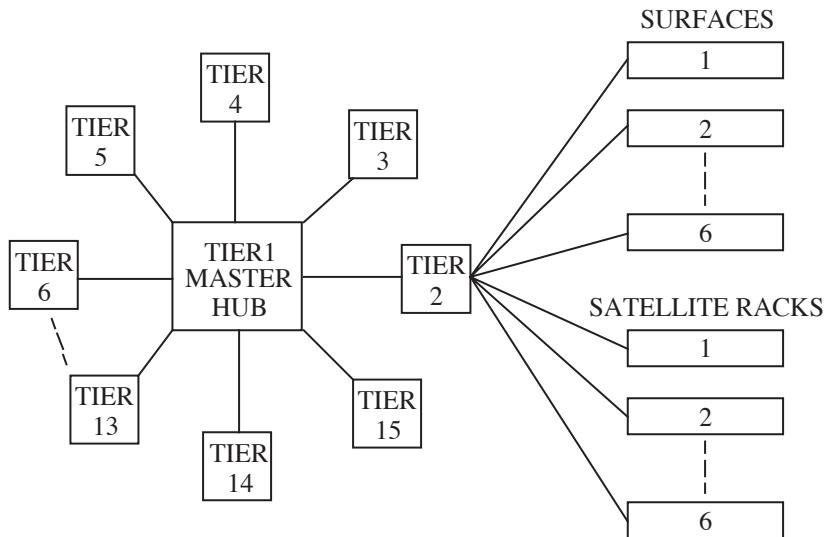

Audio transport links must be installed in pairs (i.e. a QAT Network port in the master chassis communicates to a companion QAT port card in the remote chassis). Each QAT port transceives up to 64 mono channels (32 stereo *signals*). Each AT port must be configured as Local or Remote, and Primary or Secondary. All Local/Primary ports transmit the sample rate clock while all Remote/Primary ports receive the sample rate clock and drive it onto its local backplane.

In systems incorporating control surfaces and DSP, each control surface link is made to a QAT port co-located with its corresponding DSP cards. These “MT” ports carry all fader, switch, logic, LCD meter, source and destination information to and from the control surface and the companion DSP cards located in the Remote Tier racks. Local/Remote and Primary/Secondary settings do NOT apply to ports configured as Mixer Transport links.

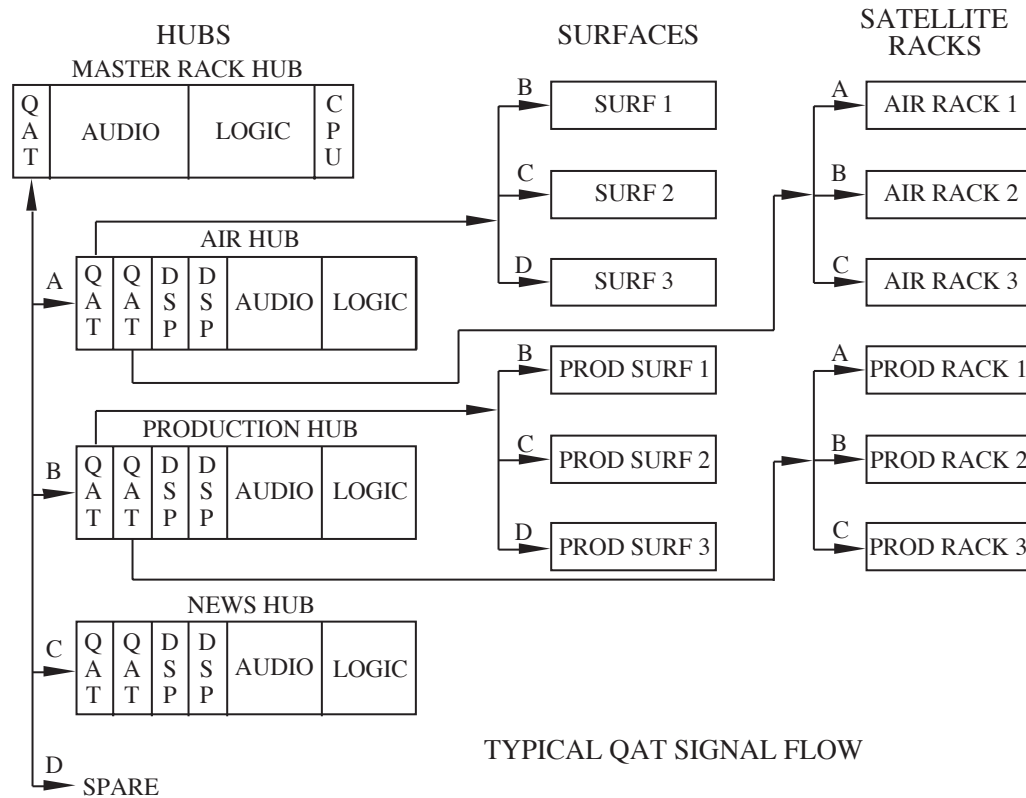

While the QAT provides a tremendous amount of flexibility and routing power, please note the following design aspects:

- There is no audio data on an MT link.
- Control surfaces may not be daisy chained together off a single MT port.
- Audio cards in a remote chassis do not communicate directly with each other.
- In a single Tier configuration, a remote chassis cannot be daisy chained to another remote chassis.

Internal Programming Options

All internal programming is done via PCB mounted dipswitches or jumpers. Dipswitch settings are summarized in the table below:

QAT-2001PCB)

NAME	REF.DES.	
RACK-ID	SW6	see Breakout Table - DIPSW6 RackID
LOCAL/REMOTE	SW9 (Ports A B C D)	LOCAL = ON REMOTE = OFF
PRIMARY/SECONDARY	SW8 (Ports A B C D)	PRIMARY = ON SECONDARY = OFF
MEDIA	SW7 (Ports A B C D)	CAT5 = ON FIBER = OFF
AUDIO CONSOLE	SW10 (Ports A B C D)	AUDIO = ON CONSOLE = OFF
SAMPLE RATE	J3	48kHz = OPEN 44.1kHz = SHORT
485_A_TERM	SW4, SW5	see Breakout Table - DIPSW1, 2, 4 & 5 485 Termination
485_B_TERM	SW1, SW2	see Breakout Table - DIPSW1, 2, 4 & 5 485 Termination
RESET	J1 = Not installed	SHORT = RESET
WATCHDOG	J2 = Installed	Factory Use Only

Switch Settings

DIPSW1, SW2, SW4 & SW5 - RS-485 Termination

SW1 - SW4

POSITION	FUNCTION	BIASED TERM	PASSIVE TERM	UNTERMINATED
1 - TX10Ω	ON=10Ω BYPASS	OFF*	ON	OFF
2 - TX+	ON=750Ω PULLUP	ON*	OFF	OFF
3 - TX-	ON=750Ω PULLDOWN	ON*	OFF	OFF
4 - 120Ω	ON=120Ω PARALLEL	ON*	ON	OFF

* Default

These four 4-position dipswitches configure the 485 port termination as follows:

Choices are Unterminated, Normal Termination, or BIAS Termination on the transmit and receive lines. SW4 and SW5 are for Port A, and SW1 and SW2 are for Port B. SW2 and SW5 are for the RS-485 transmitter's termination; SW1 and SW4 are for receiver terminations.

An RS-485 bus may only be BIAS TERMINATED at one end. All applicable QAT and CPU cards are set for BIAS TERMINATION by default. All peripheral devices are set for NO TERMINATION by default. Set the TERMINATION to ON for the last controller or console only, in an RS-485 chain.

SW3 - Reset

Momentarily pressing the switch resets the LAN chip, while pressing and holding the switch also resets the FPGA.

DIPSW6 - Rack ID

If the QAT card is a **Remote-Primary** Audio Network Card, this QAT card must supply the Rack ID to its backplane from the 4 bit onboard switch. Remote Rack ID's must be 5 or higher.

SW6 RACK ID)

RACK ID	SW6			
	RACK ID8	RACK ID4	RACK ID2	RACK ID1
1	OFF	OFF	OFF	OFF
2	OFF	OFF	OFF	ON
3	OFF	OFF	ON	OFF
4	OFF	OFF	ON	ON
5	OFF	ON	OFF	OFF
6	OFF	ON	OFF	ON
7	OFF	ON	ON	OFF
8	OFF	ON	ON	ON
9	ON	OFF	OFF	OFF
10	ON	OFF	OFF	ON
11	ON	OFF	ON	OFF
12	ON	OFF	ON	ON
13	ON	ON	OFF	OFF
14	ON	ON	OFF	ON
15	ON	ON	ON	OFF
16	ON	ON	ON	ON

MASTER CPU

RESERVED FOR STACKING

USED FOR AUDIO NETWORK CHASSIS

- Each remote chassis must have only one REMOTE-PRIMARY QAT port.

NOTE: Rack ID numbers are coded in binary: Rack ID 1 equals binary 0, Rack ID 2 equals binary 1, etc.

Rack ID's are set at the factory. Incorrect setting of these switches can cause system malfunction.

DIPSW7 - Fiber/CAT-5 Ports A-B-C-D

Selects whether the audio network or control surface connection will be made through optical fiber or copper CAT-5 cable.

DIPSW8 - Primary/Secondary Ports A-B-C-D

Some system configurations may have multiple QAT cards in each rack. The Primary setting is used to distinguish which QAT port will act as the Clock/Sync master in the Remote chassis. All other AT ports in the Remote rack must be set to Secondary.

DIPSW9 - Local/Remote (Clock Source) Ports A-B-C-D

The Local/Remote setting is required to configure QAT ports such that a Local card will operate from the backplane clock/sync references. A Remote Primary port would

likewise infer that clock/sync are to be extracted from Fiber/CAT-5 and driven onto the backplane. Local/Remote does not apply when the port type is set to CONSOLE.

NOTE:

- The system's master chassis must have only one LOCAL-PRIMARY QAT port connected to a companion remote chassis.
- Each remote chassis must have only one REMOTE-PRIMARY QAT port.

DIPSW10 - Audio/Console (Port Type) Ports A-B-C-D

Selects the type of equipment connected to each of the 4 QAT ports.

- Select AUDIO to connect a remote or master cage to the port.
- Select CONSOLE to connect a control surface to the port.

Jumper Settings

J1 - Factory Use Only - Reset

Momentary shorting does a complete reset.

J2 - Factory Use Only - Watchdog Disable

Normally installed; remove to disable watchdog reset.

J3 - Sample Rate Select - 48kHz / 44.1kHz*

Selects the system's sample rate frequency: 48kHz or 44.1kHz.

An open jumper selects 48kHz, and a shunt selects 44.1kHz.

*NOTE: When changing the audio sample rate of the GIBALTAR Network System, changes must be made in the following places: DO-2016 Digital Output Card, CPU-2001 Host CPU, and QAT-2001 Quad Audio Network Card. See the appropriate manual sections for details. In addition, any Digital Control Surface in the system must be set for the same sample rate. See the Host CPU chapter of the surface manual for details.

QAT Card Status LED's

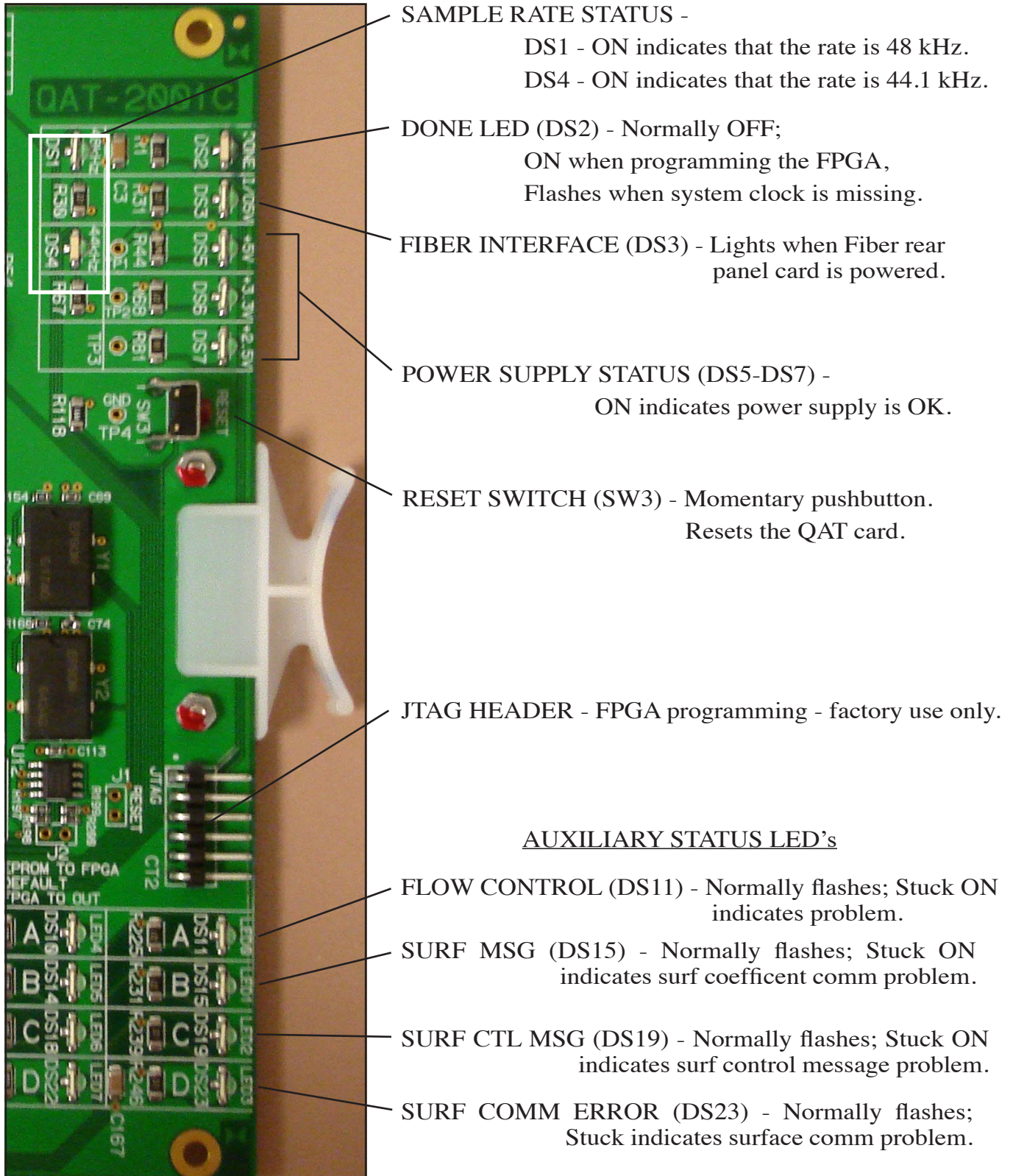

SAMPLE RATE STATUS -
 DS1 - ON indicates that the rate is 48 kHz.
 DS4 - ON indicates that the rate is 44.1 kHz.

DONE LED (DS2) - Normally OFF;
 ON when programming the FPGA,
 Flashes when system clock is missing.

FIBER INTERFACE (DS3) - Lights when Fiber rear panel card is powered.

POWER SUPPLY STATUS (DS5-DS7) -
 ON indicates power supply is OK.

RESET SWITCH (SW3) - Momentary pushbutton.
 Resets the QAT card.

JTAG HEADER - FPGA programming - factory use only.

AUXILIARY STATUS LED's

FLOW CONTROL (DS11) - Normally flashes; Stuck ON indicates problem.

SURF MSG (DS15) - Normally flashes; Stuck ON indicates surf coefficient comm problem.

SURF CTL MSG (DS19) - Normally flashes; Stuck ON indicates surf control message problem.

SURF COMM ERROR (DS23) - Normally flashes; Stuck indicates surface comm problem.

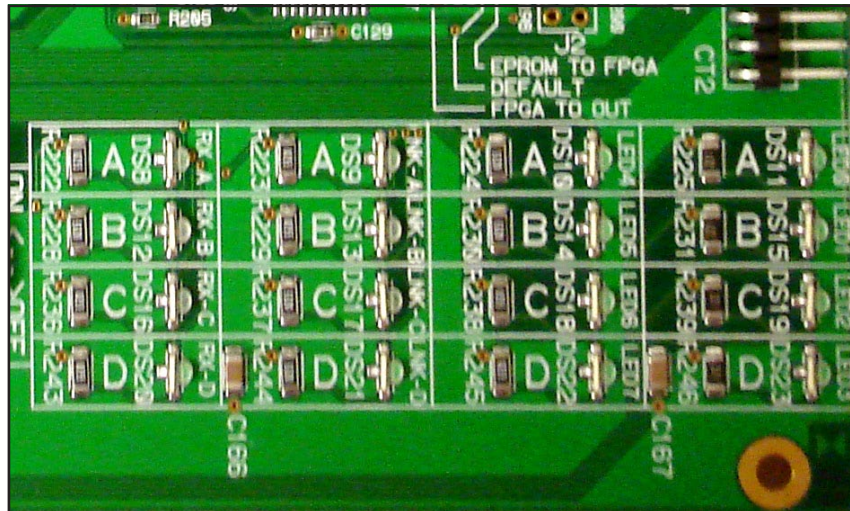

LINK STATUS LED's

RX STATUS (DS8,12,16,20) - ON indicates that the data A, B, C or D receive link is OK.

LINK STATUS (DS9,13,17,21) - ON indicates that a hardware A, B, C or D link is established.

ACTIVITY LED (DS10) - Flashes on port messages.

CLOCK MASTER (DS14) - ON indicates that this QAT card supplies the backplane clock.

COMM ERROR (DS18) - Normally OFF; ON for errors.

CFG/BUFFER ERROR (DS22) - Normally OFF; Flashes when the card is not configured. Once configured, DS22 indicates buffer errors.

Hook-Ups

All user wiring to and from the QAT-2001 card takes place at the rear I/O connector module, which can be one of three types: the QCT is used for CAT-5/6 connections made via four RJ-45 connectors, while the QOT is used for multi-mode optical fiber connections made via four SC type optical connectors or QFT made via four SFP module interface with integral LC connectors.

QCT-2001 - “A”, “B”, “C”, “D” RJ-45 – CAT-5/6 Audio Network Connections

- Pin 1 – TXD +
- Pin 2 – TXD -
- Pin 3 – RXD +
- Pin 4 – N/C
- Pin 5 – N/C
- Pin 6 – RXD -
- Pin 7 – N/C
- Pin 8 – N/C

CAT-5/6 Crossover Cable for QAT to QAT Connections

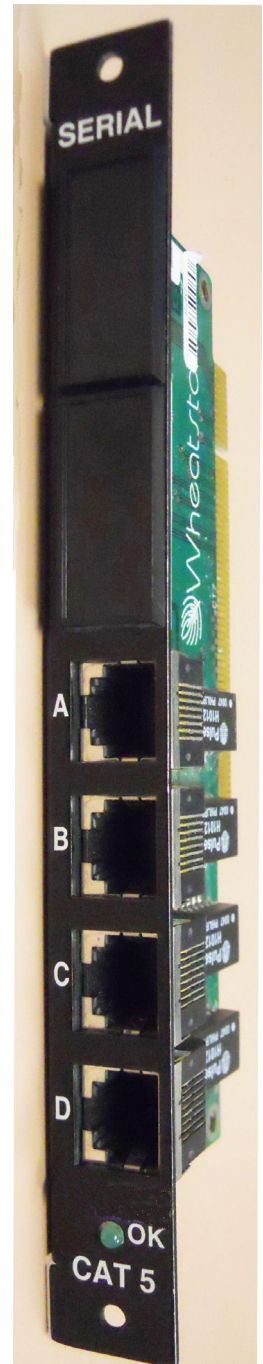
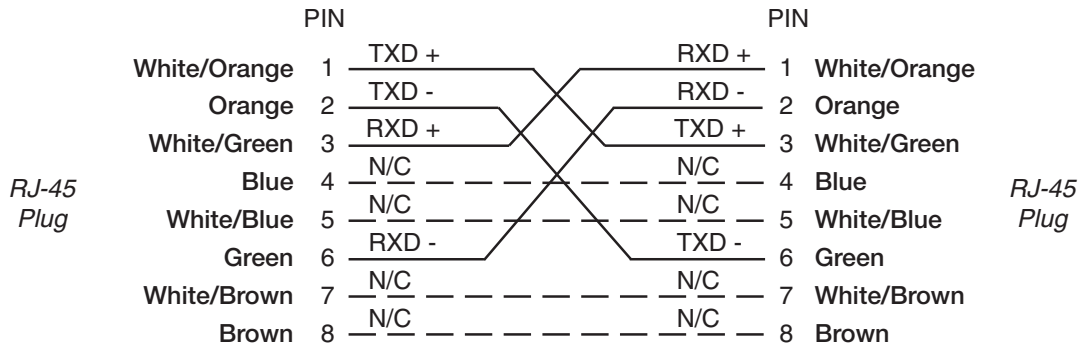

Optical Fiber Interface

QOT-2001

The OAT audio network card provides an *SC Duplex* style connector for interfacing optical fiber. The SC (subscription channel) connector is a low insertion loss, locking mechanism with excellent strain relief characteristics. The following AMP® part number may be used to reference the physical characteristics of the required mating connector.

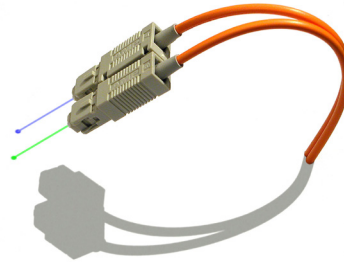

AMPSC Duplex connector Kit Part Number: 504657-1



Optical Fiber Cable

The typical optical fiber cable required in this application is a multimode, glass core cable, with a core/cladding size of $62.5/125 \mu m$, suitable for low-to-moderate-speed data links (≤ 100 Mbps). The full-duplex nature of the audio network interface requires one fiber for transmit, and one for receive; hence dual zip cables are recommended.

Optical fiber cables are manufactured with a variety of jacket materials, which directly affects cable cost, including Thermoplastic Elastomer (TPE), Kynar® and Teflon® FEP. Physical properties of the jacket material determine a cable's resistance to abrasions, flame retardancy, etc. *Check local codes to be sure the cable you plan on using is compliant in your application.*

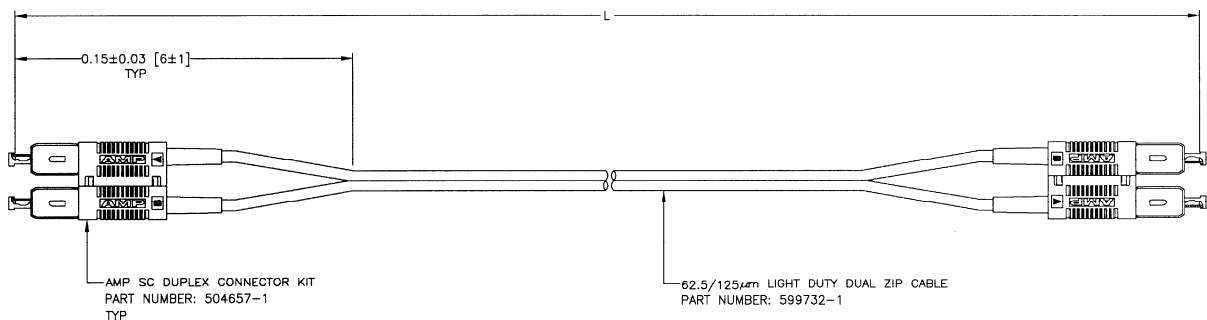
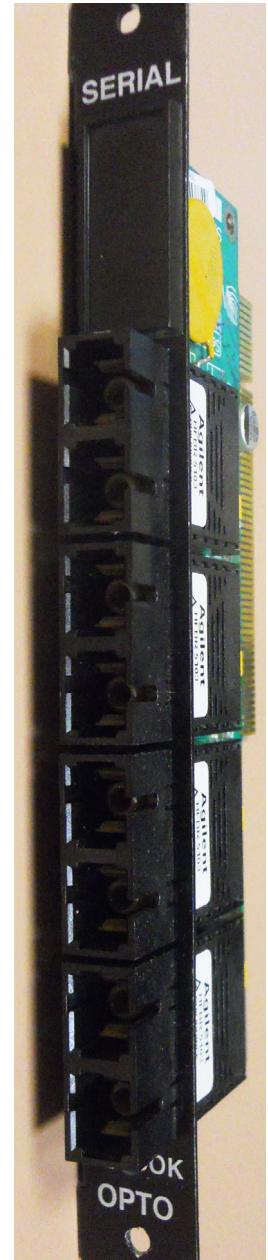

DIMENSIONS IN [] ARE IN INCHES.

QFT-2001

The QFT supports a fiber connection via an SFP module interface with integral LC connectors.

Optical Transceiver

Optical Transceivers convert physical signals from electrical to optical (and vice-versa) in a network and couple the optical signals into (and out of) optical fiber. Small form factor pluggable (SFP) transceivers, used in the QFT, are designed to be hot-swappable in industry standard cages and connectors (for easy field repair), and offer high speed and physical compactness.

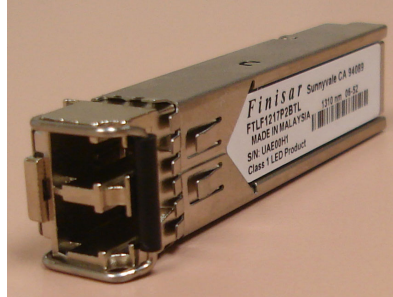

Optical Transceiver

Connector Type

The high-density *LC Duplex* connector has a tabbed locking mechanism similar to what you would find on a phone jack. This enables secure connectivity and easy removal.

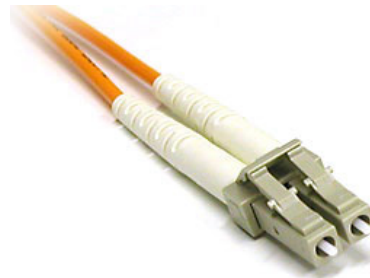

Optical Fiber Cable

The typical optical fiber cable required in this application is multi-mode or single-mode duplex fiber optic cable. The specific type depends on the optical SFP transceiver selected.

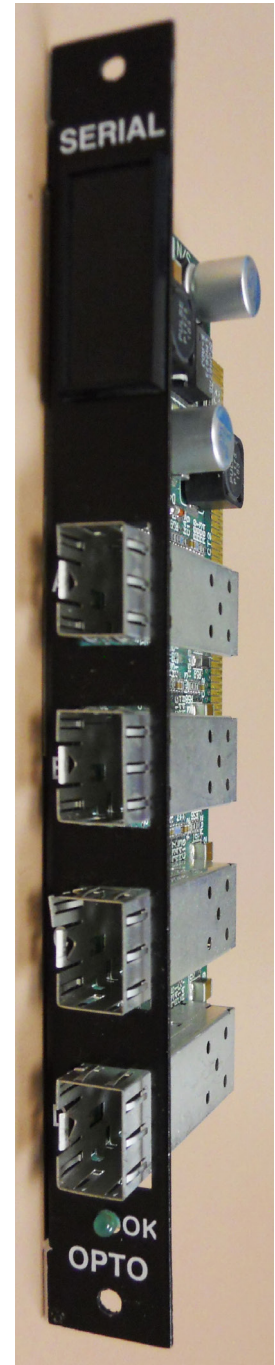

THIS PAGE IS INTENTIONALLY LEFT BLANK

Logic Input/Output Card (LIO-2001)

Overview

The LIO-2001 is a programmable hardware GPI with a feature set designed for broadcast studio control applications. Twelve independent, opto-isolated solid state relay inputs and outputs may be programmed through the XPoint GUI software to function as routable logic or trigger ports.

Routable logic allows the user to make logic signal crosspoints in the same way audio crosspoints are made. For instance, a closure on logic input port 1 can be cross connected to logic output port 1. Later, the same closure on input port 1 can be routed to logic output port 2, 3 or 4 etc. as required. The *output* ports may be programmed to follow the input port state or to invert it. Defining this behavior is useful when configuring the hardware for normally closed applications. Input and output ports may be configured as logic I/O only or may be “attached” to an audio signal. Routable logic signals may be included as part of a Salvo.

Trigger ports allow the user to program a logic *input* to fire a predefined Salvo or to make a temporary audio connection. Salvos make or break multiple audio and/or logic crosspoints, while temporary audio connections are useful for IFB or EAS applications. When an input port is defined as a trigger port, the corresponding output port is automatically allocated for tally back. Tally back outputs provide a momentary closure whenever the corresponding input is activated. Note that trigger ports serve one predefined function and are not routable.

See “Configuring Logic I/O” in the Software Setup guide.

Input Ports

Each of the twelve LH1522AB solid state relay input ports are configured as a floating photodiode, (i.e. + input is the opto’s anode, - input is the opto’s cathode). A 475 ohm current limiting resistor in series with each negative input supports an external supply voltage range of +5Vdc to +15Vdc. For external supply voltages between +15Vdc and +24Vdc, install a current limiting resistor of 220 ohms in series with each + input connection. Maximum forward photodiode current is 50mA.

When interfacing to a logic input port, we recommend the positive side be connected to a fixed, positive dc voltage and the negative side switched to ground to activate the logic input.

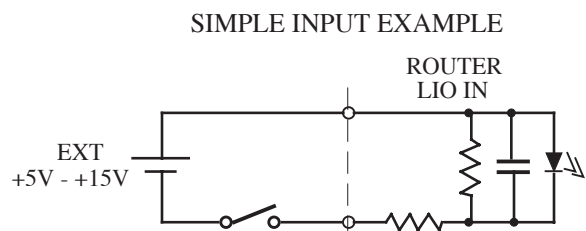

Output Ports

Each of the twelve LH1522AB solid state relay outputs may be configured in software to function as normally open or normally closed circuits when cross connected to an input. Routable output ports can be programmed to default to the ON, OFF, or CURRENT states when disconnected from an input port.

All outputs feature linear ac/dc operation, current limiting, and a low on resistance, typically 10 ohms.

Normal Operating Load Limits: 120mA, ±100V

Safety Note: *The LIO-2001 is NOT designed to safely switch AC mains power.*

SIMPLE OUTPUT EXAMPLE

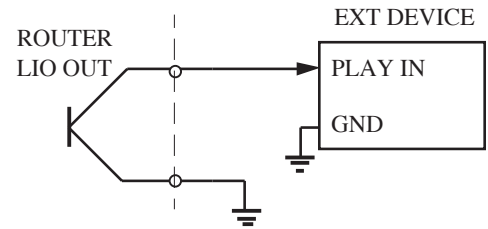

Typical Input/Output Circuit

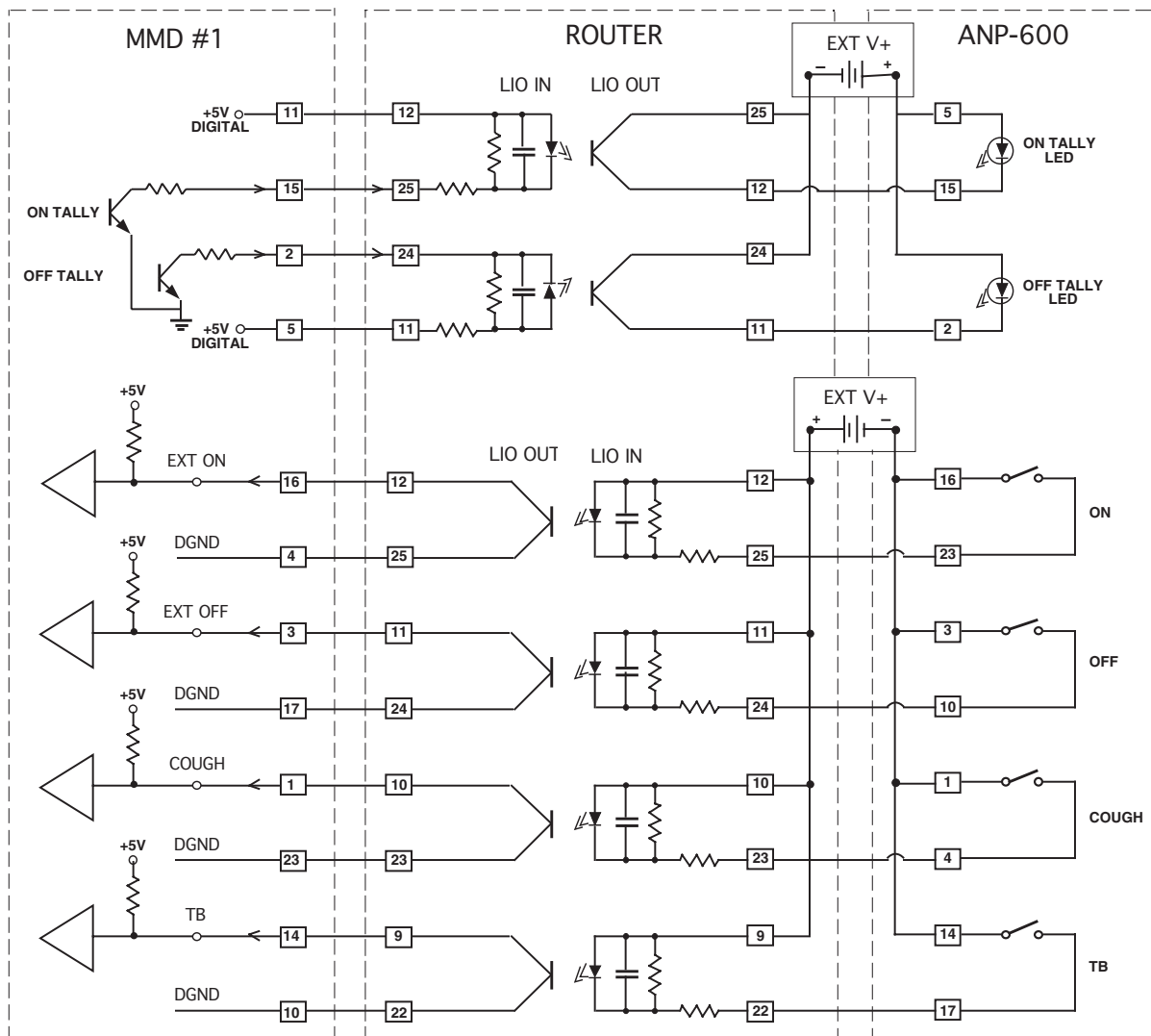

Mic Logic Interface

The previous discussion implies the use of the 2DB-2001 rear panel with the LIO-2001 card. Wheatstone also provides an LRJ-2001 rear panel to aid in wiring remote user panels for microphone channel logic interface.

The LRJ-2001 employs three RJ-45 connectors to provide connections for Remote On, Remote Off, Cough, and Talkback logic inputs, and Tally On and Tally Off logic outputs, for three microphone remote user panels. Two additional RJ-45 connectors provide access to the remaining six logic outputs.

To effectively use the LRJ-2001 you will need to understand the LIO-2001 programming details (see “Configuring Logic I/O” in the XPoint Software Setup Guide later in the manual). You also need to know how the LRJ-2001 connections “map” to the logic input and output ports of the LIO-2001. The following tables shows that mapping:

TABLE 1 LRJ-2001 INPUT PORT MAPPING

INPUT PORTS	CONNECTOR	PIN	FUNCTION
1	M1	2	Mic 1 Cough
2	M1	3	Mic 1 TB to CR
3	M1	6	Mic 1 Remote Off
4	M1	7	Mic 1 Remote On
5	M2	2	Mic 2 Cough
6	M2	3	Mic 2 TB to CR
7	M2	6	Mic 2 Remote Off
8	M2	7	Mic 2 Remote On
9	M3	2	Mic 3 Cough
10	M3	3	Mic 3 TB to CR
11	M3	6	Mic 3 Remote Off
12	M3	7	Mic 3 Remote On

TABLE 2 LRJ-2001 OUTPUT PORT MAPPING

INPUT PORTS	CONNECTOR	PIN(S)	FUNCTION
1	M1	4	Mic 1 Tally Off
2	M1	5	Mic 1 Tally On
3	M2	4	Mic 2 Tally Off
4	M2	5	Mic 2 Tally On
5	M3	4	Mic 3 Tally Off
6	M3	5	Mic 3 Tally On
7	S1	6, 7	Logic 7 Out+, Out-
8	S1	4, 5	Logic 8 Out+, Out-
9	S1	2, 3	Logic 9 Out+, Out-
10	S2	6, 7	Logic 10 Out+, Out-
11	S2	4, 5	Logic 11 Out+, Out-
12	S2	2, 3	Logic 12 Out+, Out-

Connecting the Wheatstone ANP-RJ mic user panel to the LRJ-2001 is simply a matter of connecting the two with a straight (not a crossover) CAT-5 cable, as indicated in the following drawing:

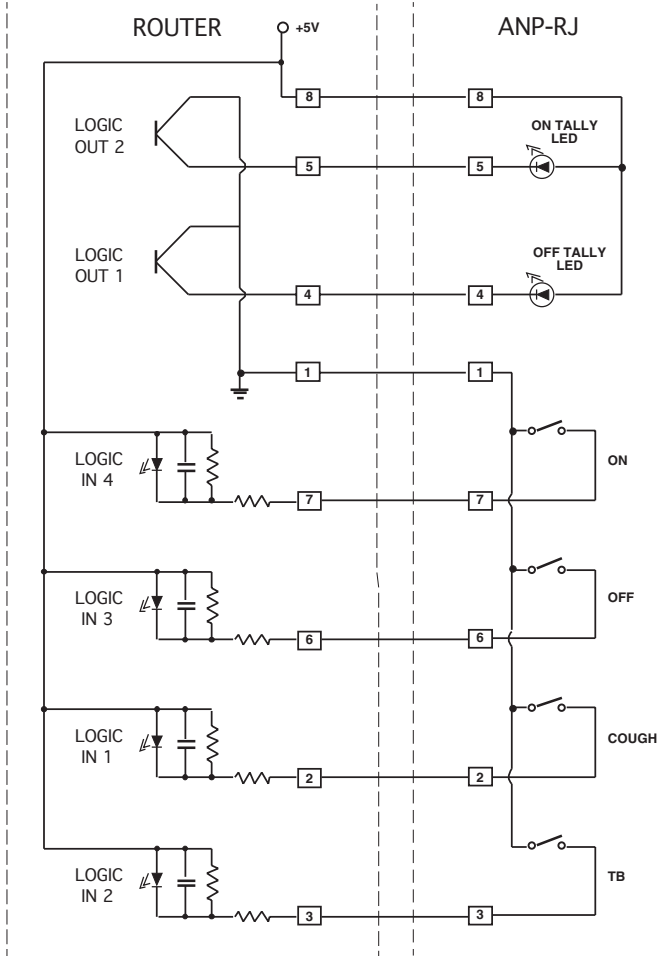

Software Programming

For details on programming the LIO-2001, please refer to “Configuring Logic I/O” in the XPoint Software Setup Guide later in this manual.

Internal Programming Options

There are no user programming options on the LIO-2001 card.

Jumper/Dipswitch Settings

- J1 - Not Installed.
- J2 - Default IN - FPGA reset enable.
- J3 - Not Installed.

- SW1-4 - Not Used.

Logic Input/Output Card Status LED's

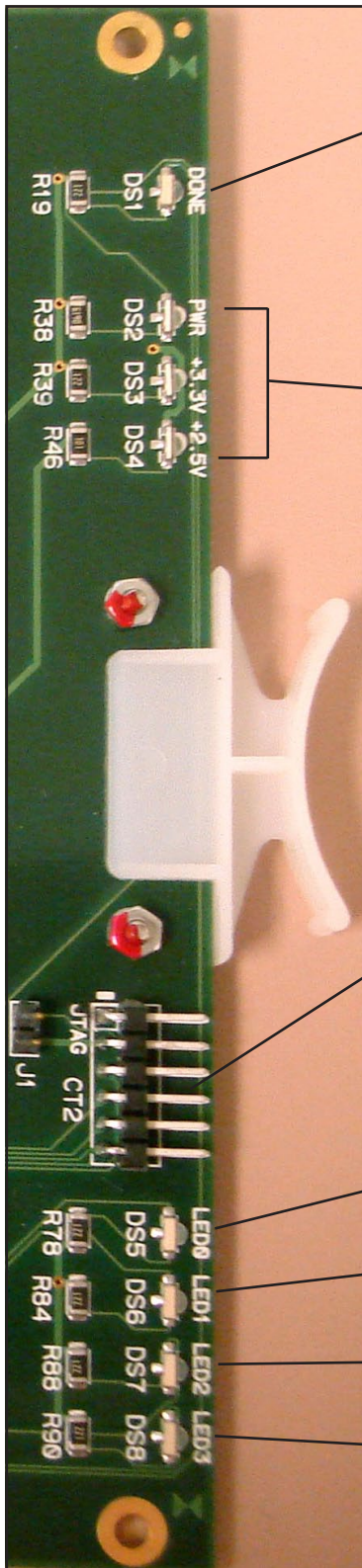

DONE LED (DS1) - Normally OFF;
ON when programming the FPGA,
Flashes when system clock is missing.

POWER SUPPLY STATUS (DS2-DS4) - ON indicates power
supply is OK.

JTAG HEADER - FPGA programming - factory use only.

AUXILIARY STATUS LED's

SYS ACTIVITY LED (DS5) - Flashes on config messages.

INPUT PORT ACTIVITY (DS6) - Flashes on logic input message.

OUTPUT PORT ACTIVITY (DS7) - Flashes on logic output message.

CFG STATUS (DS8) - ON when card is not configured.

Hook-Ups

All user wiring to the LIO-2001 card takes place at the rear I/O connector module (2DB or LRJ). The 2DB module has two female DB-25 connectors and the LRJ has five RJ-45 connectors for logic input and output connections.

Upper DB-25 – Logic Input Connections

These include 12 input sources. Pinout drawing on page 2-74 shows all wiring connections at a glance.

Pin 12 – Logic 1 In +

Pin 25 – Logic 1 In -

Pin 11 – Logic 2 In +

Pin 24 – Logic 2 In -

Pin 10 – Logic 3 In +

Pin 23 – Logic 3 In -

Pin 9 – Logic 4 In +

Pin 22 – Logic 4 In -

Pin 8 – Logic 5 In +

Pin 21 – Logic 5 In -

Pin 7 – Logic 6 In +

Pin 20 – Logic 6 In -

Pin 6 – Logic 7 In +

Pin 19 – Logic 7 In -

Pin 5 – Logic 8 In +

Pin 18 – Logic 8 In -

Pin 4 – Logic 9 In +

Pin 17 – Logic 9 In -

Pin 3 – Logic 10 In +

Pin 16 – Logic 10 In -

Pin 2 – Logic 11 In +

Pin 15 – Logic 11 In -

Pin 1 – Logic 12 In +

Pin 14 – Logic 12 In -

Lower DB-25 – Logic Output Connections

These include 12 output sources. Pinout drawing on page 2-74 shows all wiring connections at a glance.

Pin 12 – Logic 1 Out +

Pin 25 – Logic 1 Out -

Pin 11 – Logic 2 Out +

Pin 24 – Logic 2 Out -

Pin 10 – Logic 3 Out +

Pin 23 – Logic 3 Out -

Pin 9 – Logic 4 Out +

Pin 22 – Logic 4 Out -

Pin 8 – Logic 5 Out +

Pin 21 – Logic 5 Out -

Pin 7 – Logic 6 Out +
 Pin 20 – Logic 6 Out -
 Pin 6 – Logic 7 Out +
 Pin 19 – Logic 7 Out -
 Pin 5 – Logic 8 Out +
 Pin 18 – Logic 8 Out -
 Pin 4 – Logic 9 Out +
 Pin 17 – Logic 9 Out -
 Pin 3 – Logic 10 Out +
 Pin 16 – Logic 10 Out -
 Pin 2 – Logic 11 Out +
 Pin 15 – Logic 11 Out -
 Pin 1 – Logic 12 Out +
 Pin 14 – Logic 12 Out -

LRJ-2001 – Logic I/O Connections

The RJ-45 M1-M3 connectors include microphone (MIC 1 - MIC 3) control functions for remote on and off, cough, talkback, and tally. The RJ-45 S1 and S2 spare connectors provide access to the remaining logic output connections. Pinout drawing on pages 2-75 shows all wiring connections at a glance.

RJ-45 M1 – MIC #1 Control Connections

Pin 1 – Audio Ground
 Pin 2 – Cough - Logic 1 In
 Pin 3 – TB to CR - Logic 2 In
 Pin 4 – Tally Off - Logic 1 Out
 Pin 5 – Tally On - Logic 2 Out
 Pin 6 – Remote Off - Logic 3 In
 Pin 7 – Remote On - Logic 4 In
 Pin 8 – +5V Digital

RJ-45 M2 – MIC #2 Control Connections

Pin 1 – Audio Ground
 Pin 2 – Cough - Logic 5 In
 Pin 3 – TB to CR - Logic 6 In
 Pin 4 – Tally Off - Logic 3 Out
 Pin 5 – Tally On - Logic 4 Out
 Pin 6 – Remote Off - Logic 7 In
 Pin 7 – Remote On - Logic 8 In
 Pin 8 – +5V Digital

RJ-45 M3 – MIC #3 Control Connections

Pin 1 – Audio Ground
 Pin 2 – Cough - Logic 9 In
 Pin 3 – TB to CR - Logic 10 In
 Pin 4 – Tally Off - Logic 5 Out
 Pin 5 – Tally On - Logic 6 Out

Pin 6 – Remote Off - Logic 11 In
Pin 7 – Remote On - Logic 12 In
Pin 8 – +5V Digital

RJ-45 S1 and S2 – Spare Logic Output Connections

RJ-45 S1 Pin 1 – Audio Ground
RJ-45 S1 Pin 2 – Logic 9 Out +
RJ-45 S1 Pin 3 – Logic 9 Out -
RJ-45 S1 Pin 4 – Logic 8 Out +
RJ-45 S1 Pin 5 – Logic 8 Out -
RJ-45 S1 Pin 6 – Logic 7 Out +
RJ-45 S1 Pin 7 – Logic 7 Out -
RJ-45 S1 Pin 8 – +5V Digital
RJ-45 S2 Pin 1 – Audio Ground
RJ-45 S2 Pin 2 – Logic 12 Out +
RJ-45 S2 Pin 3 – Logic 12 Out -
RJ-45 S2 Pin 4 – Logic 11 Out +
RJ-45 S2 Pin 5 – Logic 11 Out -
RJ-45 S2 Pin 6 – Logic 10 Out +
RJ-45 S2 Pin 7 – Logic 10 Out -
RJ-45 S2 Pin 8 – +5V Digital

LIO (2DB) Panel Logic Input/Output Connections

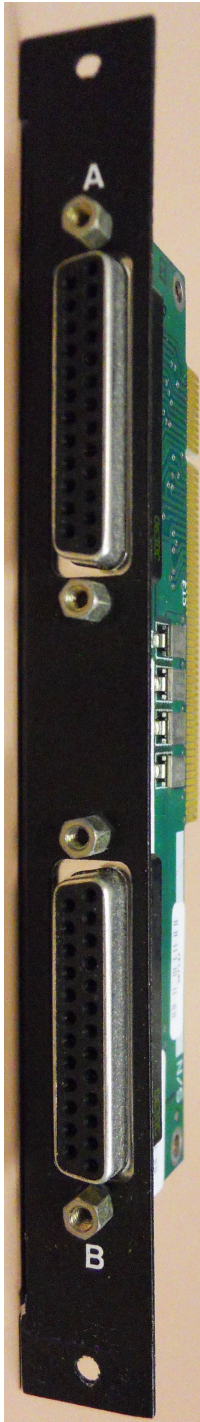

*Upper "A"
DB-25*

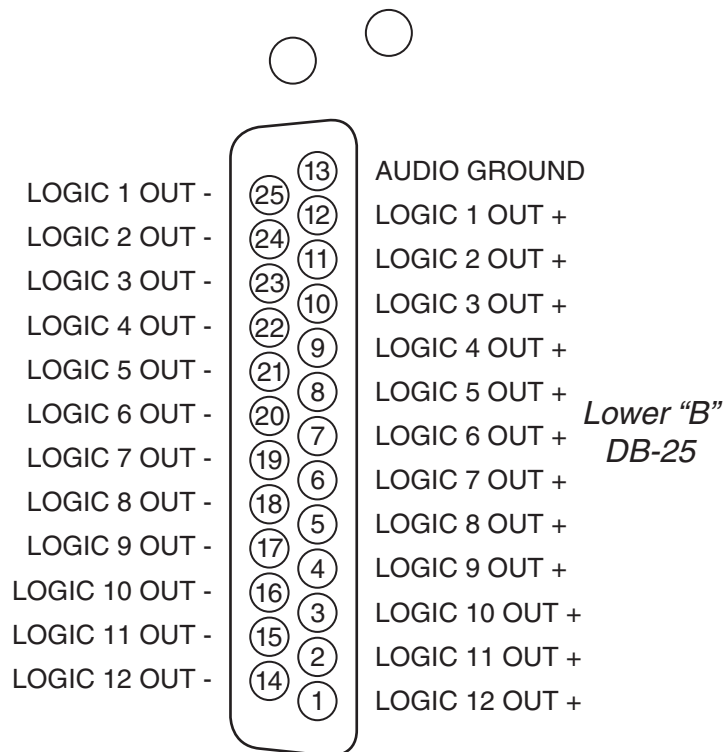
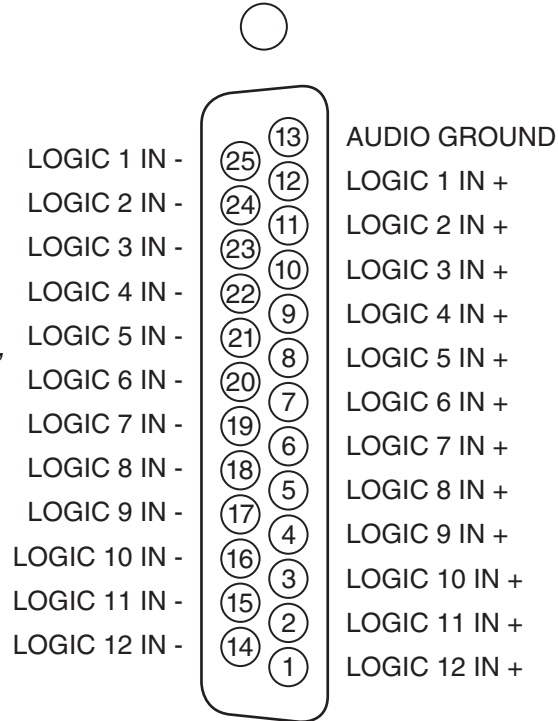

*Lower "B"
DB-25*

LRJ Panel Logic Input/Output Connections

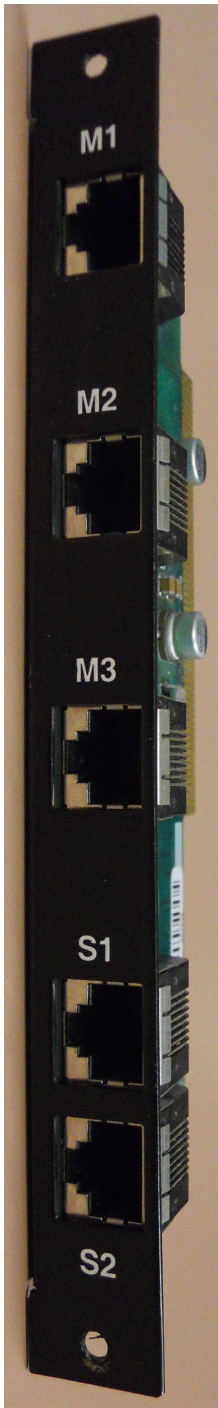

MIC 1

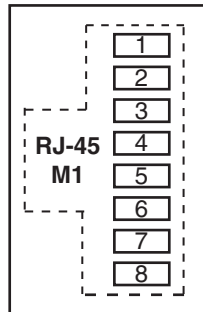

AUDIO GROUND
COUGH
TB TO CR
TALLY OFF
TALLY ON
REMOTE OFF
REMOTE ON
+5V DIGITAL

SPARE 1

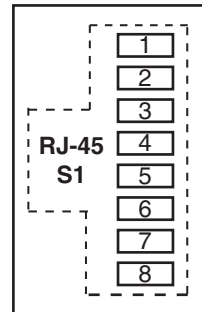

AUDIO GROUND
LOGIC 9 OUT +
LOGIC 9 OUT -
LOGIC 8 OUT +
LOGIC 8 OUT -
LOGIC 7 OUT +
LOGIC 7 OUT -
+5V DIGITAL

MIC 2

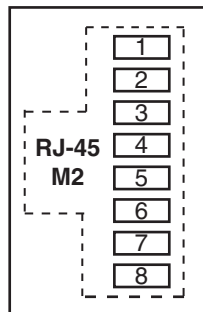

AUDIO GROUND
COUGH
TB TO CR
TALLY OFF
TALLY ON
REMOTE OFF
REMOTE ON
+5V DIGITAL

SPARE 2

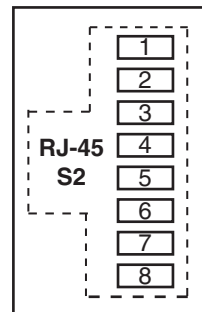

AUDIO GROUND
LOGIC 12 OUT +
LOGIC 12 OUT -
LOGIC 11 OUT +
LOGIC 11 OUT -
LOGIC 10 OUT +
LOGIC 10 OUT -
+5V DIGITAL

MIC 2

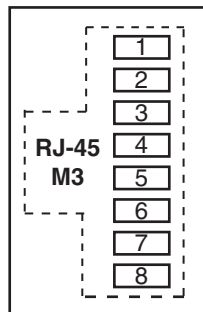

AUDIO GROUND
COUGH
TB TO CR
TALLY OFF
TALLY ON
REMOTE OFF
REMOTE ON
+5V DIGITAL

Digital Signal Processor Card (DSP-2001)

Overview

The DSP-2001 card is the digital signal processing card used by the GIBALTAR NETWORK system to mix and condition input signals. DSP cards in a given system are physically identical. Their functionality is determined by input and mix software which is loaded into each DSP card's memory on *surface* power up. Wheatstone's XPoint software is used to map each DSP card to specific control surfaces and audio racks.

DSP cards are installed in pairs for radio style control surfaces, with one DSP card acting as an input signal conditioner and the other as a mix engine. Larger production and television surfaces with 5.1 surround capabilities have a dedicated Master Mix engine along with multiple Mix and Input DSP cards. The exact number of DSP cards requisite in large systems is a function of the number of input channels and mix bus requirements.

Each input fader has a dedicated DSP channel which is responsible for gain, mode, phase, EQ, dynamics, and metering. Likewise, each output mix has a dedicated DSP channel responsible for summing, gain, mode, metering, and EQ/Dynamics on 5.1 Master mix outputs. DSP cards receive instructions from control surfaces in real time over a Mixer Transport or "MT" link. The mix engine DSP's combine all of the console audio signals as directed by a console's faders, knobs and switches to produce the various Program, Aux Send, Mix Minus and Monitor output mixes.

Racks may be fitted with one or more backup or "self healing" DSP cards. If a hardware problem disables a primary DSP card, the affected surface will load the appropriate code into one of the backup DSP cards and continue to function. Replacing the faulty primary DSP card will return the surface to normal operation, freeing the backup card for future use. Warning messages present on the surface and in the XPoint GUI indicate that a card has failed and requires attention.

Internal Programming Options

All internal programming is done via PCB mounted switches.

Switch Settings

SW1 - DSP Reset Switch

Momentarily pressing and holding this switch resets the DSP and reloads software from the surface.

DIPSW2 - Not Used

Jumper Settings

J1 - Factory Use Only - Watchdog Reset

Momentary shorting does a complete reset.

J2 - Factory Use Only - Watchdog Reset

Momentary shorting does a complete reset.

J3 - Factory Use Only - Watchdog Disable

Normally installed; remove to disable watchdog reset.

Mix Engine Digital Signal Processor Card (DSP-2009)

Overview

There are two types of DSP-2009 cards – the EQ and MIXER cards. These digital signal processing cards are used by the GIBRALTAR NETWORK system to mix and condition input signals. Their functionality is determined by the physical chipsets installed on the card and by the input and mix software which is loaded into each DSP card's memory on *surface* powerup. Wheatstone's XPoint software is used to map each DSP card to specific control surfaces and audio racks.

Large production and television surfaces with 5.1 surround capabilities have a dedicated Master Mix engine along with multiple Mix and Input DSP cards. The exact number of DSP cards requisite in large systems is a function of the number of input channels and mix bus requirements.

Each input fader has a dedicated DSP channel which is responsible for gain, mode, phase, EQ, dynamics, and metering. Likewise, each output mix has a dedicated DSP channel responsible for summing, gain, mode, metering, and EQ/Dynamics on Master mix outputs. DSP cards receive instructions from control surfaces in real time over a Mixer Transport or "MT" link. The mix engine DSP's combine all of the console audio signals as directed by a console's faders, knobs and switches to produce the various Program, Aux Send, Mix Minus and Monitor output mixes.

Racks may be fitted with one backup "self healing" DSP card. If a hardware problem disables a primary DSP card, the affected surface will load the appropriate code into the backup DSP card and continue to function. Replacing the faulty primary DSP card will return the surface to normal operation, freeing the backup card for future use. Warning messages present on the surface and in the XPoint GUI indicate that a card has failed and requires attention.

Internal Programming Options

All internal programming is done via PCB mounted switches.

Switch Settings

DIPSW1 - Factory Use Only

Normally all positions must be off.

SW2 and SW3 - Factory Use Only

SW4 - DSP Reset Switch

Momentarily pressing and holding this switch resets the DSP and reloads software from the surface.

Jumper Settings

J1, J2, and J3 - Factory Use Only

DSP-2009 Card Status LED's

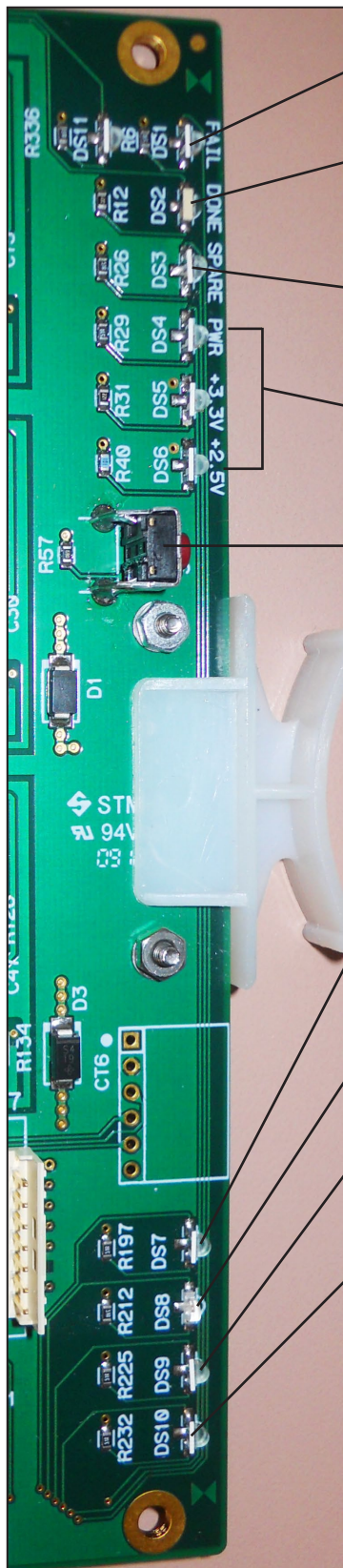

FAIL (DS1) - Normally OFF;

Lights to indicate card failure.

DONE LED (DS2) - Normally OFF;

ON when programming the FPGA,
Flashes when system clock is missing.

ERROR (DS3) - Normally OFF;

Lights to indicate clock error.

POWER SUPPLY STATUS (DS4-DS6) - ON indicates power
supply is OK.

RESET SWITCH (SW4) - Momentary pushbutton. Hold for
2 seconds for complete reset of
CPU and FPGA.

BACKPLANE RESPONSE (DS7) - Lights as the card responds
to backplane messages.

MESSAGE (DS8) - ON indicates that messages are being
received from control surface.

SYNC (DS9) - ON indicates clock SYNC signal.

CONFIGURATION (DS10) - ON indicates card needs
configuration from HOST.

NOTE: Normal operation is (3) power status LEDs always ON,
all other LEDs OFF, except DS7 lights once every
 ≈ 40 seconds and DS8 flickers in response to control
changes on the control surface.

Serial Digital Interface Card (SDI-2001)

Overview

The SDI-2001 card provides a way to connect SD-SDI (270Mbps) or HD-SDI (1.5Gbps) embedded serial video signals directly to the GIBRALTAR audio router for audio extraction.

The XPoint software is used to configure which AES audio Groups will be extracted from the A and B inputs on the SDI card. Each SDI input is capable of extracting two AES Groups for a total of eight 24 bit audio channels from a single SD or HD SDI bit stream. Users can configure the extracted audio to appear as mono, stereo, or surround sources in the GIBRALTAR router matrix.

Format and Standards Compliance

The SDI card uses state of the art chipsets to auto-detect and lock to the format of the incoming video signal. Both standard definition and high definition SDI signals are supported in a variety of line and frame rates including:

525/59.94, 625/50, 720p/59.94, and 1080i/59.94.

Applicable SMPTE standards this device complies with are:

SMPTE 259M, 272M, 292, and 299M.

Physical Interface

Two sets of 75 ohm BNC connectors are provided on the SDI-2001's modular rear panel: [A Input - A Loop] and [B Input - B Loop]. Wire destinations from your embedded router or other SDI devices directly to the A or B inputs. All connections are made with HD video grade 75 ohm coaxial cable terminated to male BNC connectors. Rear panel LINK LED's will illuminate whenever an SDI signal is present on the A or B inputs. The Loop output connectors are provided for testing purposes and are not intended to drive external devices over long cable runs.

Synchronization

The GIBRALTAR router or WHEATNET must be locked to a house sample rate of 48kHz. Synchronization is achieved by wiring AES "black" to the AES sync input connectors located on DB-9 connectors of the system's primary and backup CPU modules. For WHEATNET installations, wire to the EXT Clock connectors. Typical installations may use a "balun" to impedance match a 75 ohm AES reference signal to the 110 ohm impedance of the sync inputs. Please refer to the *Host CPU* or WHEATNET section for wiring details.

SDI Card Configuration

Per applicable SMPTE specifications, up to 16 mono audio channels may be embedded into the SD or HD SDI bit stream. These 16 audio channels are divided into 8 pairs and 4 audio groups as follows:

AES Group	AES Pairs	Audio Channels	
		Pair i	Pair ii
1	1 & 2	1 - 2	3 - 4
2	3 & 4	5 - 6	7 - 8
3	5 & 6	9 - 10	11 - 12
4	7 & 8	13 - 14	15 - 16

Each BNC input on the SDI card can be configured to extract any two AES GROUPS embedded in the video bit stream. Use the SDI card's CARD DEFS form to tell the card which GROUPS to extract on the SDI card's rear panel A and B inputs.

AES Group Selection

Select Configure>AdvXP>Rack Defs form in the XPoint menu. Use the Tier Id and/or Rack Id spin dials to find the Rack holding the card you want to configure. Left-click the colored bar representing the card in question and click the Card Definitions button at the bottom of the popup window to display the form below. Use this form to define which AES Groups each BNC connector will extract. This is usually done once at installation time. For example, in your plant stereo audio may be embedded in the first two channels of Group 1 and surround sources may be embedded in the first 6 channels of Groups 1 and 2. Select Group 1 and 2 for extraction. You will now be able to extract stereo or surround signals from any SD or HD SDI signal routed to the input.

Card Definitions

Location

Tier: 1 Tier1

Rack: 1 Rack1

Card: 10 SDI Disable View as IOC

SDI Config

BNC A Group Select

Bridge Circuits 1-4

1 AES Group

2

3

4

Bridge Circuits 5-8

1

2 AES Group

3

4

BNC B Group Select

Bridge Circuits 9-12

1 AES Group

2

3

4

Bridge Circuits 13-16

1

2 AES Group

3

4

OK Apply Cancel Signal Definitions

Audio Signal Mapping

Each SDI input is capable of extracting 2 AES Groups - 8 audio channels - from a single embedded video signal. These 8 extracted channels are then mapped into 8 circuits on the SDI card in order to get them into the router's backplane for distribution. Each SDI card has 16 available circuits or "wires." *Circuits 1-8* are reserved for the SDI card's "A" input while *Circuits 9-16* are reserved for the SDI card's "B" input. The AES Groups selected for extraction on the Card Definitions form are linearly mapped into these reserved circuits.

Audio Signal Creation

Once the AES Groups have been selected you can use the "Modify Signal Definitions" form to create mono, stereo, or surround audio source signals. These signals appear as *Sources* in the XPoint matrix and map the audio channels in the selected AES Groups to "Circuits" in the GIBRALTAR router backplane. *Circuits 1-8* are dedicated to the "A" SDI input while *Circuits 9-16* are dedicated to the "B" SDI input.

Stereo Signal Example

We previously set up the SDI card to extract *AES Groups 1 and 2* on the "A" and "B" connectors. In this case *AES Group 1: Pair 1: Channels 1-2* are extracted from the SDI card's "A" input and mapped to GIBRALTAR *Circuits 1-2*. Remember, GIBRALTAR *Circuits 1-8* are reserved for the "A" connector of the selected SDI card.

	Card #	Card Type	Circuit #
Left	5	SDI	1
Right	5	SDI	2
Center	6		13
LFE	6		14
Left Surround	6		15
Right Surround	6		16

Surround Signal Example

Here is a typical surround input. In this case the surround signal is embedded in to the first 6 channels of an HD-SDI signal connected to the SDI card's B input connector. We previously configured the card's B input to extract *AES Groups 1 and 2* and *Circuits 9-16* are reserved for the B connector of the SDI card. With this in mind, *Circuits 9-10* are the first AES pair, 11-12 are the 2nd AES pair, and 13-14 are the 3rd AES pair extracted from the HD-SDI input signal.

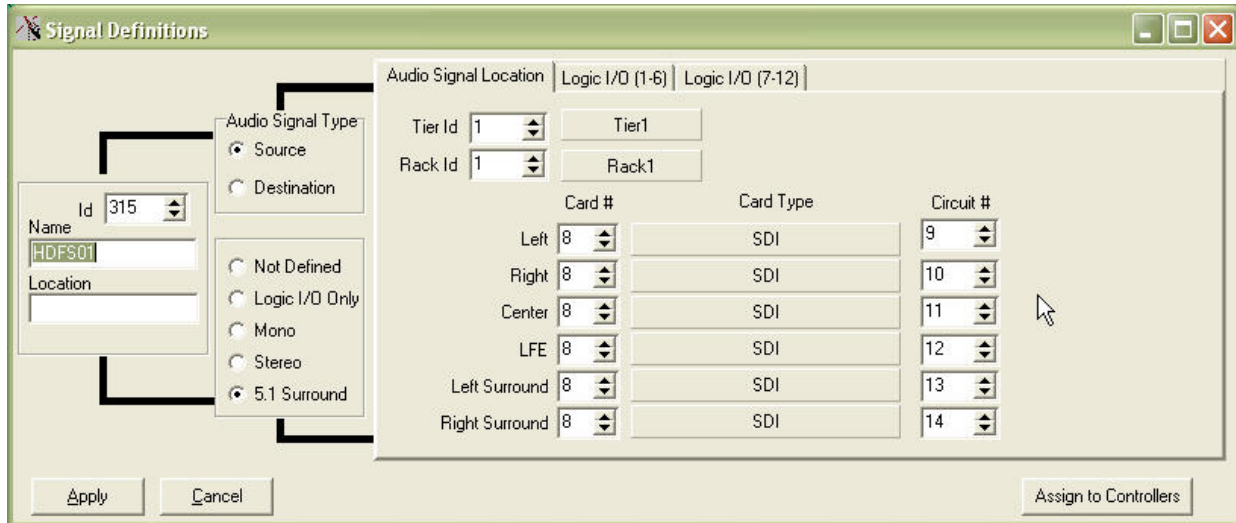

Internal Programming Options

There are no user programming options on the SDI-2001 card.

Serial Digital Interface Card Status LED's

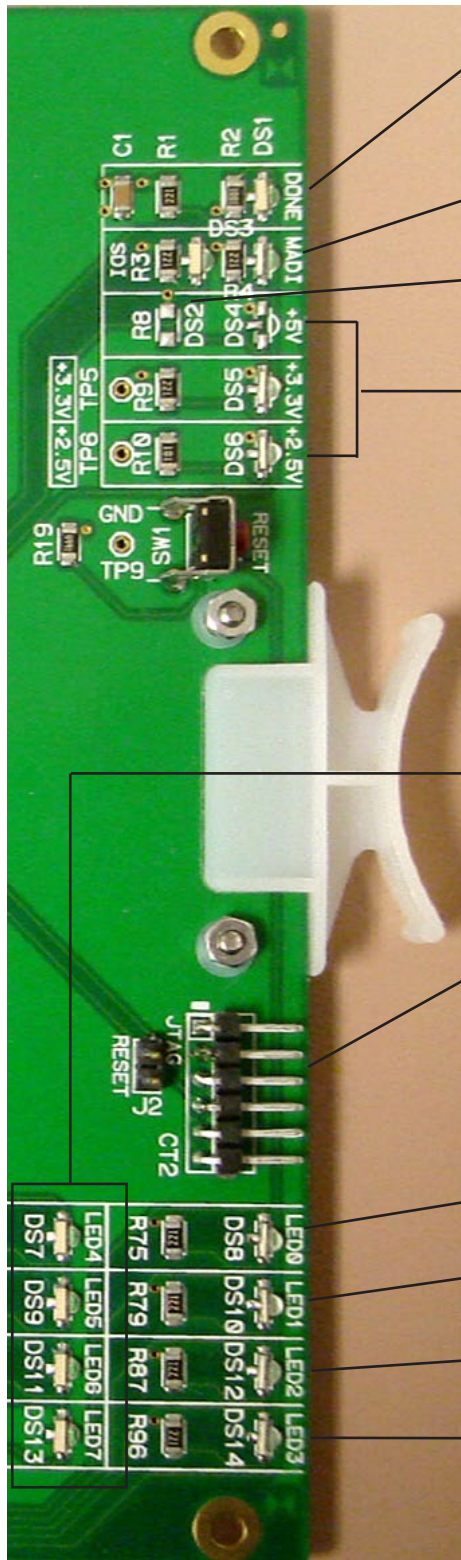

- DONE LED (DS1) - Normally OFF;
ON when programming the FPGA,
Flashes when system clock is missing.
- MADI LED (DS3) - Lights if MADI firmware is loaded.
- SDI LED (DS2) - Lights if SDI firmware is loaded.
- POWER SUPPLY STATUS (DS4-DS6) - ON indicates power supply is OK.

- LED (DS7)
 - LED (DS9)
 - LED (DS11)
 - LED (DS13)
- Factory use only.

JTAG HEADER - FPGA programming - Factory use only.

AUXILIARY STATUS LED's

- SDI A LOCKED (DS8) - ON if SDI signal is present on the A input.
- SDI B LOCKED (DS10) - ON if SDI signal is present on the B input.
- DS12 - Not Used.
- CFG STATUS (DS14) - ON when card is not configured.

Hook-Ups

All user wiring to and from the SDI-2001 Card takes place at the rear I/O connector module that contains four BNC connectors for use with 75 ohm digital audio equipment.

SDI – Serial Video Connections

This panel is used only for the SDI-2001 card.

BNC A IN – SD/HD SDI Video Input - 75 ohm

BNC A LOOP – A Test Port Use Only

BNC B IN – SD/HD SDI Video Input - 75 ohm

BNC B LOOP – B Test Port Use Only

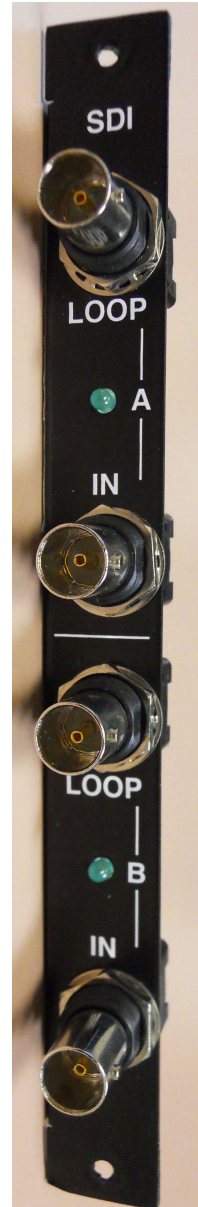

Multichannel Audio Digital Interface Card (MADI-2001)

Overview

The MADI-2001 card provides a way to connect MADI signals directly to the GIBRALTAR audio router for audio insertion or extraction to and from the MADI stream.

The XPoint software is used to map the 64 mono input and 64 mono output MADI channels supported by the card. Users can freely configure the MADI channels to appear as mono, stereo, or surround sources and destinations in the GIBRALTAR router matrix.

Format and Standards Compliance

MADI (Multichannel Audio Digital Interface) is an AES standard originally released in 1991 as AES10-1991. The format was originally conceived as a method for interfacing large format mixing consoles to the digital multi-track tape recorders manufactured by Sony and Mitsubishi being used at the time. The original MADI standard included a mechanism for handling 56 bi-directional channels at a variable sample rate. The vari-speed capability of the digital multi-track machines is accomplished by slewing the sample rate by a factor of roughly +/- 12%. While support for vari-speed was included in the original MADI spec, it is not a requirement for pure routing applications. By dropping the vari-speed option users gain an additional 8 channels bringing the total channel count to 64.

The current MADI format as used by broadcasters, film, and recording industries supports 64 channels at a fixed sample rate. The MADI-2001 card supports either 56 or 64 channels at a fixed sample rate of 44.1kHz or 48kHz.

Applicable AES standards this device complies with are:

AES10-1991, AES10-2003, and AES-10id-2005.

Physical Interface

The MADI-2001 card supports either copper or fiber connectivity.

A pair of 75 ohm BNC connectors are provided on the MADI-2001's modular rear panel and are labeled MADI IN and OUT. All connections should be made with a high quality 75 ohm coaxial cable terminated to male BNC connectors. By installing digital video grade coax, cable runs of 200M or more can be realized.

A single SC (subscription channel) style connector is provided on the modular rear panel for connecting the MADI interface via two strands of multimode fiber. Adapters are commercially available to convert the SC connector to LC if required. Multimode (graded index) fiber supports fiber runs up to 2kM.

A rear panel LINK LED will illuminate when a MADI input signal is present.

Synchronization

MADI requires that the devices at both ends of the MADI link be synchronized. Use an AES reference, sometimes called DARS (digital audio reference signal), to lock the GIBRALTAR router as described below.

The GIBRALTAR router or WHEATNET must be locked to a house sample rate of 44.1kHz or 48kHz. Synchronization is achieved by wiring AES “black” to the AES sync input connectors located on a DB-9 connector of the system’s primary and backup CPU modules. For WHEATNET installations, wire to the EXT Clock connectors. Typical installations may use a “balun” to impedance match a 75 ohm AES reference signal to the 110 ohm impedance of the sync inputs. Please refer to the Host CPU or WHEATNET section for wiring details.

MADI Card Configuration

There is only one card configuration option called MONO MODE. This is set by default at the factory and there is usually no need to change this setting. Even when set to MONO MODE you can pass stereo or even 5.1 signals across the MADI interface.

Legacy equipment receiving MADI from the GIBRALTAR may require this setting to be turned off, that is unchecked.

Behind the scenes, this setting sets or clears the MADI stream bit location:

“Bit2:Channel notA/B.”

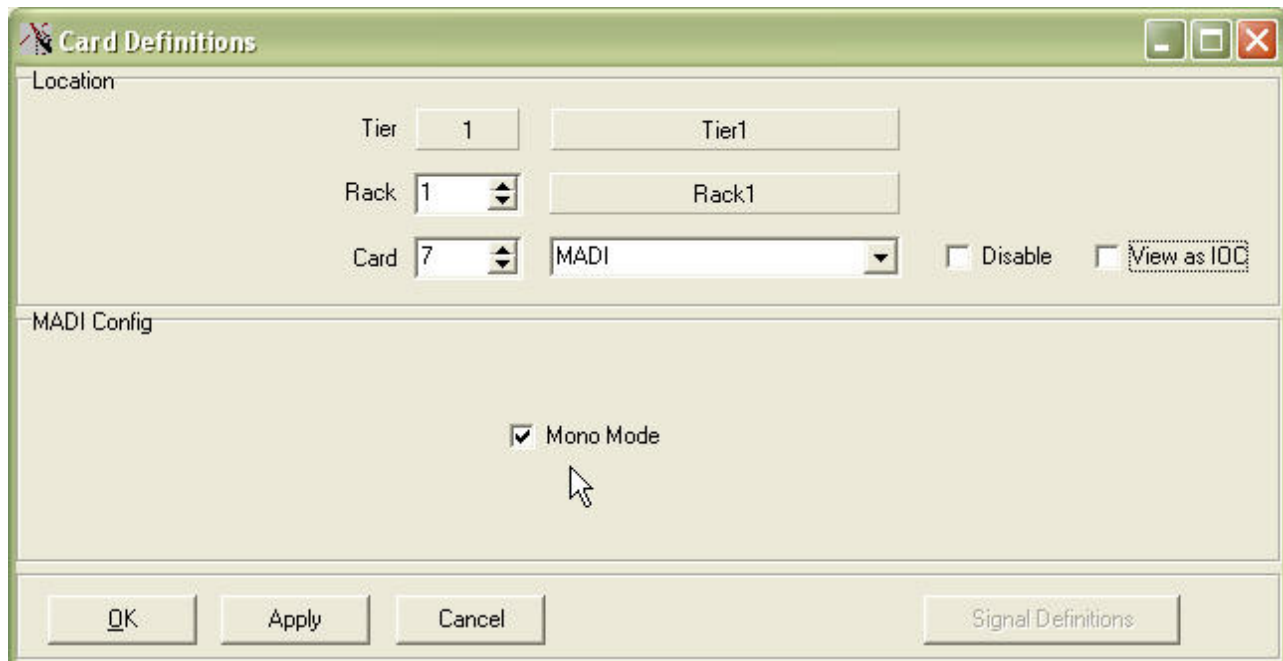

Audio Signal Mapping

The GIBALTAR router is capable of routing up to 64 mono source channels to the MADI output. These 64 output channels are mapped as Destination signals in the Wheatstone routing software. These 64 destination channels may be grouped into any combination of Mono, Stereo, or 5.1 destination signals. You can freely route any source in the GIBALTAR router to any MADI destination.

Likewise, the GIBALTAR router is capable of receiving up to 64 mono channels from the MADI input. These 64 input channels are mapped as Source signals in the Wheatstone routing software. These 64 input channels may be grouped into any combination of Mono, Stereo, or 5.1 Source signals. You can freely route any MADI source signal to any destination in the GIBALTAR router, including MADI outputs.

Audio Signal Creation

The MADI card is pre-configured at the factory with 64 mono Source signals and 64 mono Destination signals. Use the “Modify Signal Definitions” form in XPoint to rename or change the mono signals to stereo, or surround audio signals.

Mono Signal Example

Here is a typical mono MADI input signal. The Signal Type is set as a Source - Mono. The Audio Location identifies which physical card cage, card slot, and MADI channel the signal will be associated with.

The screenshot shows the 'Signal Definitions' window with the following configuration:

- Audio Signal Type:** Source (selected), Destination
- Audio Signal Location:** Logic I/O (1-6) | Logic I/O (7-12)
- Tier Id:** 1 (Tier1)
- Rack Id:** 1 (Rack1)
- Card #:**
 - Left: 7
 - Right: 4
 - Center: 18
 - LFE: 18
 - Left Surround: 18
 - Right Surround: 18
- Card Type:** MADI
- Circuit #:**
 - Left: 64
 - Right: 8
 - Center: 1
 - LFE: 1
 - Left Surround: 1
 - Right Surround: 1
- Name:** MADI 64
- Location:** MADI
- Audio Signal Type (Detailed):** Not Defined, Logic I/O Only, Mono (selected), Stereo, 5.1 Surround
- Buttons:** Apply, Cancel, Assign to Controllers

Stereo Signal Example

Here is a typical stereo input. The Signal Type is set as a Source - Stereo. The Audio Location identifies which physical card cage, card slot, and MADi channels the signal will be associated with. When creating stereo signals always put the left channel on an ODD circuit number and place the right channel on the next higher circuit number.

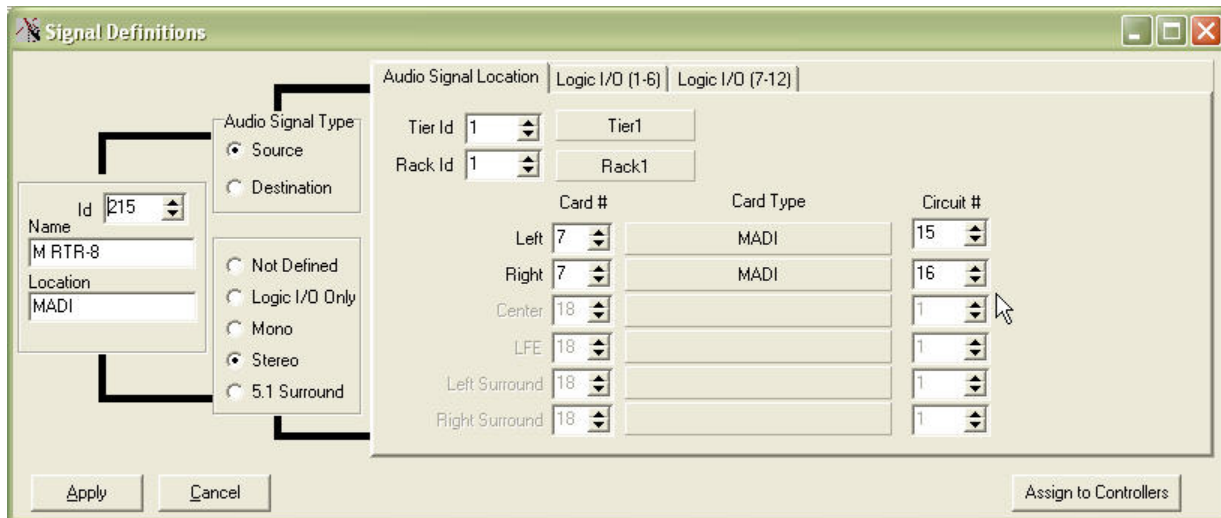

Internal Programming Options

There are no user programming options on the MADI-2001 card.

Multichannel Audio Digital Interface Card Status LED's

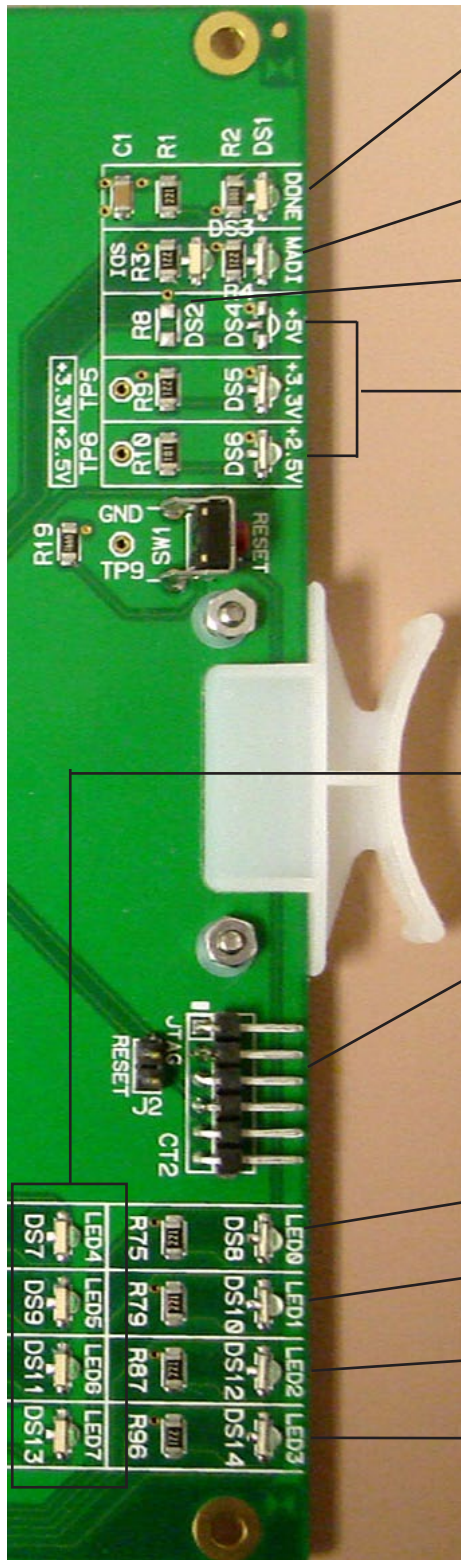

- DONE LED (DS1) - Normally OFF;
ON when programming the FPGA,
Flashes when system clock is missing.
- MADI LED (DS3) - Lights if MADI firmware is loaded.
- SDI LED (DS2) - Lights if SDI firmware is loaded.
- POWER SUPPLY STATUS (DS4-DS6) - ON indicates power supply is OK.

- LED (DS7)
 - LED (DS9)
 - LED (DS11)
 - LED (DS13)
- Factory use only.

JTAG HEADER - FPGA programming - factory use only.

AUXILIARY STATUS LED's

- Flashes on config messages.
- MADI LOCKED (DS10) - ON if MADI signal is present and locked.
- DS12 - Not Used.
- CFG STATUS (DS14) - ON when card is not configured.

Hook-Ups

All user wiring to and from the MADI-2001 Card takes place at the rear I/O connector module. This rear module is used only for the MADI-2001 card.

Digital Audio Connections

A pair of 75 ohm BNC connectors are provided on the rear panel for input and output connections. All connections should be made with a high quality 75 ohm coaxial cable terminated to male BNC connectors. By installing digital video grade coax, cable runs of 200M or more can be realized.

- BNC IN Pin 1 – HI
- BNC IN Pin 2 – SH
- BNC OUT Pin 1 – HI
- BNC OUT Pin 2 – SH

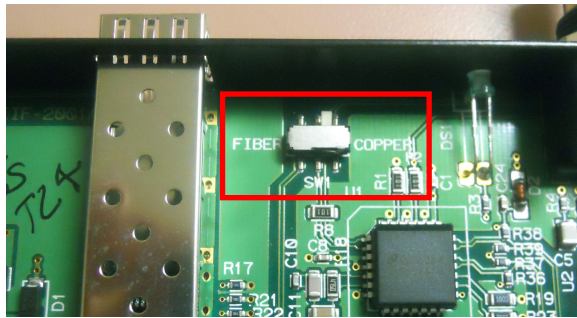

SW1 on the top center part of the MADIIF-2001 PCB should to be in the COPPER position to use the BNC connectors, or in the FIBER position to use the Fiber cable.



Optical Fiber Interface

The MADI supports a fiber connection via an SFP module interface with integral LC connectors.

Optical Transceiver

Optical Transceivers convert physical signals from electrical to optical (and vice-versa) in a network and couple the optical signals into (and out of) optical fiber. Small form factor pluggable (SFP) transceivers, used in the MADI, are designed to be hot-swappable in industry standard cages and connectors (for easy field repair), and offer high speed and physical compactness.

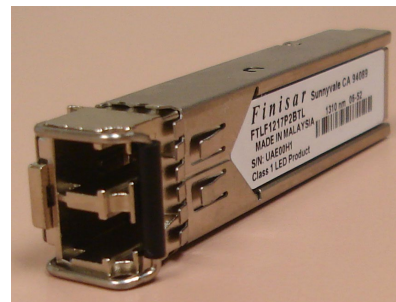

Optical Transceiver

Connector Type

The high-density *LC Duplex* connector has a tabbed locking mechanism similar to what you would find on a phone jack. This enables secure connectivity and easy removal.

Optical Fiber Cable

The typical optical fiber cable required in this application is multi-mode or single-mode duplex fiber optic cable. The specific type depends on the optical SFP transceiver selected.



Controller Devices

Chapter Contents

XP Configuration GUI.....	3-2
PC_XYC - Optional Controller Software.....	3-3
Ethernet-Based Controllers.....	3-5

Controller Devices

The GIBRALTAR NETWORK router has provisions for both software control and hardware control.

Software configuration and control of the system is handled by the XPoint Configuration GUI described below.

A wide range of convenient and powerful Ethernet-based controllers will help keep your network system future-proof.

XP Configuration GUI

The supplied Windows™ application, XPoint, is a password protected graphical user interface (GUI) which allows the user to configure, monitor and control the GIBRALTAR NETWORK router. The XP GUI communicates using TCP/IP over Ethernet to the GIBRALTAR host CPU card. Once the system is configured the XP program does not have to be continuously running.

The primary function of the XPoint GUI is to provide the engineer or administrator with a means to define the configuration of the hardware installed in the system. Configuration menus allow the engineer access to hardware definitions for audio I/O cards, XY rack controllers, serial port use, I/O signal names, etc. The administrator also has control over programmable features such as Salvo creation and crosspoint locking. Further, certain levels of system diagnostics may be accessed.

The XP GUI also provides a birds eye view of the current connection status of the entire network router via a crosspoint grid display of the available sources (inputs) and destinations (outputs). This GUI is also used to associate human readable names with each of the signal sources and destinations.

The XPoint application program is supplied to the end user on an installation CD ROM.

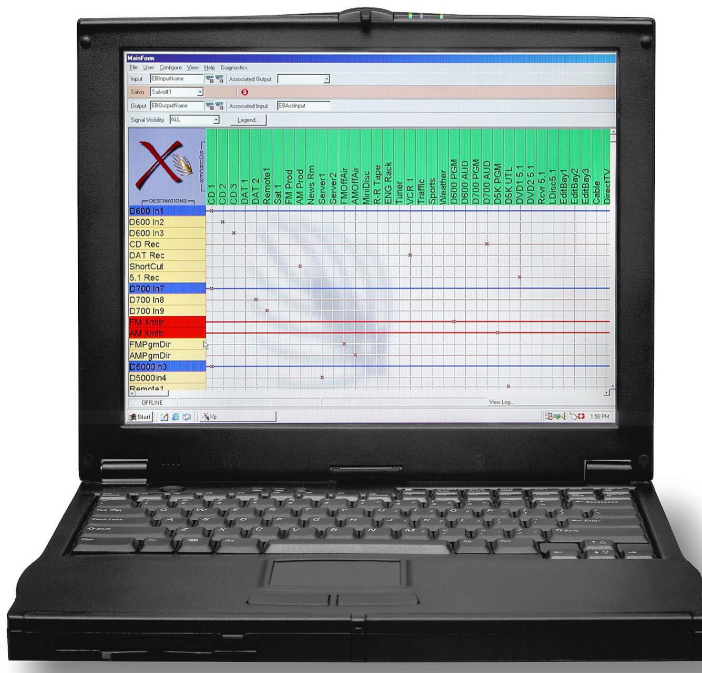

Please see the “XPoint Software Setup Guide” (Chapter 4) for detailed software information.

PC_XYC - Optional Controller Software

The PC_XYC application is an optional software package that can be purchased to provide additional control of crosspoint connections from other PC's connected on the network. This eliminates the need for new wiring and hardware in certain locations and provides multi-user access to "mapped" system resources. A demo version of the program is provided on the installation CD.

When the program is first started the screen at right appears. The application is simple in operation and is comprised of three buttons, SOURCE, TAKE, and DESTINATION.



Some initial setup is necessary. Right click anywhere on the program screen except for the buttons themselves. From the popup menu that appears, select *Set Broadcast Port*, and a popup appears. The Broadcast Port must be set to the same port number as is used by the GIBRALTAR system, and set on the *Advanced Crosspoint Configuration* form (see page 4-4). This is typically 55555.



Once the Broadcast Port is properly set, basic operation is simple. Click the blue DESTINATION button and a list of available sources and salvos shows up. Please note, if your computer is not on the same subnet as the GIBRALTAR CPU you will not see your system names, but will only see default numbers. To make a crosspoint connection, select a destination from the list. The destination name now shows up on the blue button face. Next, click on the green SOURCE button to see the list of available sources. Select one by clicking on its name, and its name now shows up on the face of the green button. Click on the red TAKE button and the specified connection will be made. To break a connection, select the destination and then select NO SRC as the source, then click TAKE.

Firing a salvo is done by clicking the blue button and selecting a salvo. The salvo name will show up on the blue button and **Salvo>>>** will show up on the green button. Click TAKE to fire.

There are a few other items of interest that show up when the right click popup menu is showing.

Sort Signals By... - choose whether the listed sources, destinations, and salvos are sorted by name or by signal ID number.

Visibilities - first brings up a password entry form. To continue, enter the password. The default password is *Admin*. Once the password is entered the *Visibility* form shows up, as shown below.

Change Password - as mentioned above, the default password to change visibilities is *Admin*. This entry allows you to change the password. You will need to enter the current password, then enter the new password twice.

Set Broadcast Port - As previously mentioned, this allows you to set the Broadcast Port the program will use. This must be the same as the Broadcast Port the GIBALTAR uses.

Show Log - this allows you to view the log that is maintained by the program as it handles crosspoint requests. It may be handy for troubleshooting.

About - shows you the program version number.

Exit - allows you to exit the program. You can also exit by clicking the 'X' box in the upper right corner of the program window.

The *Visibility* form allows you to set the signals that will be visible when the SOURCE and DESTINATION buttons are clicked. There are three tabs, for *Sources*, *Destinations*, and *Salvos*. On any given tab there are two list windows. The windows on the left shows all the *Available* signals, while the window on the right shows the *Assigned* signals, the ones that will be visible in operation. Regardless of what signals are showing in the window on the right, if the *Select All* box is checked all signals of that type will be visible. So in addition to moving the desired signals over to the window on the right, make sure the *Select All* box is unchecked if you want limited visibility.

The signals in the list are sorted by signal ID by default. Clicking the *Sort by...* button allows you to sort by *Name*, *ID - Name*, or *Name - ID*. When sorting by *ID - Name*, both the name and the ID of the signals are shown; the ID appears first, followed by the name, with the signals appearing in order by the ID. When sorting by *Name - ID* the name appears first in the list, followed by the ID. This can be useful if you have signals that share a common name, and are elsewhere distinguished by the *Location* attribute (see page 4-21 on defining signals for more detail). When sorting by *Name* only you will not be able to distinguish shared names.

When done setting visibilities, click *OK*. Don't forget to uncheck *Select All* on each tab where you are trying to limit visibilities.

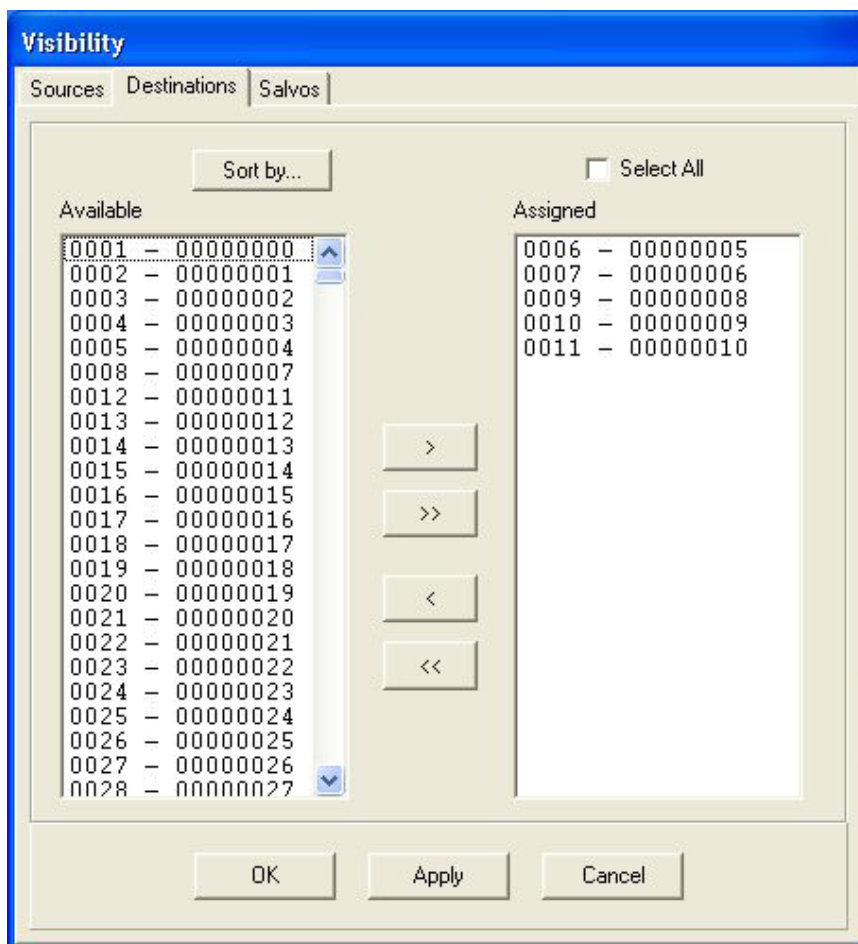

Ethernet-Based Controllers

There are rackmount versions and modular versions of the Ethernet-based Controllers. All variations of those controllers are shown on pages 1-21 and 1-22. Choose from eight or sixteen button source selectors, dual source select panels, or even single and dual X-Y panels.

All those controllers have similar functions. By turning the SOURCE knob, the available inputs are displayed in the 8-character display window. When the desired input source is scrolled into the display window, the TAKE button will light up. Pressing the TAKE button will execute the take command on the downstroke: the TAKE button lights goes off and the desired input source is selected. Note that if the TAKE button is not pressed in a timeout period of 6-8 seconds, the display will revert to its previous setting.

Some controllers have PROGRAMMABLE buttons to program input sources. To program the desired input source for a selected button, press the button and hold it for a few seconds. The display window will display <STORED>, and the desired input source will be stored for this button.

When the SOURCE knob is scrolled to a programmed input source, the associated button lights to indicate the correspondence between the source and button.

The Ethernet-Based Controllers connect to your network system via RJ-45 ethernet connectors.

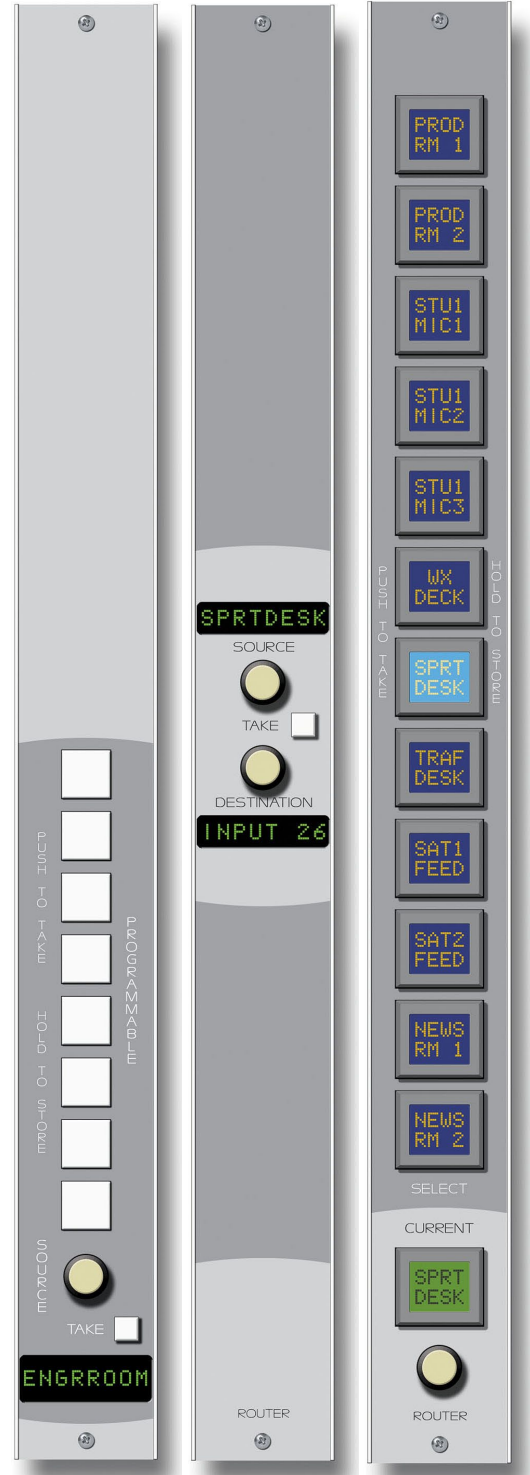

XPoint Software Setup Guide

Chapter Contents

GIBRALTAR Ethernet/IP Address Quick Start	4-3
Ethernet Cabling.....	4-3
Default IP Address.....	4-3
Changing your PC's IP Address	4-3
Changing the GIBRALTAR's IP Address	4-4
Configuring IP Address in XPoint Software.....	4-4
Saving the GIBRALTAR Configuration	4-4
Getting Started.....	4-5
GUI Log-In	4-5
Passwords.....	4-5
Connection Between the Configuration GUI and Master Rack.	4-6
System Configuration Menus.....	4-9
Tier Configuration.....	4-9
Control Surface Configuration.....	4-10
Rack Configuration.....	4-11
Adding a Card to a Rack	4-12
Card/Signal Definition	4-12
Audio/Mixer/Quad Network Card Definition.....	4-12
CPU Card Definition	4-12
LIO Card Definition	4-12
Mic and Variable Line Gain Card Definition.....	4-12
Analog Card Definition	4-14
Digital Card Definition.....	4-15
Viewing Defined Source & Destination Signals	4-16
Configuration Rules.....	4-16
Completing the Configuration	4-17
Saving Your Configuration.....	4-17
Config.txt File	4-17
Signal Definition	4-20
Alias Signals	4-21
Configuring Logic I/O.....	4-23
Overview.....	4-23
Routable Logic	4-23
Triggered Port Logic.....	4-23
Routable Logic Signal Definitions	4-24
Defining Routable Logic Functions	4-25
Viewing Defined Logic Signals	4-25
Configuring Triggered Port Logic	4-26

Signal Locking	4-27
Salvo Definition	4-27
Control Surface Configuration	4-29
Surface Visibility Settings	4-29
VDip Settings.....	4-30
Line Gain	4-31
Microphone Gain.....	4-31
Mix Minus Polarity	4-31
Password Modes.....	4-32
Programmable Buttons	4-32
Special Functions - Console Locks.....	4-33
Console Presets	4-33
Tool Bars	4-35
Main Menu Summary.....	4-37
File Menu	4-37
User Menu	4-37
Configure Menu.....	4-37
View Menu	4-38
Help Menu	4-38
Diagnostics Menu.....	4-38
Diagnostics Menu Examples	4-39
Setting Up an Air Tally with the GIBALTAR Router System.....	4-40
Step 1 - Create a Logic Destination in the XPoint Matrix.....	4-40
Step 2 - Modify the VDip settings	4-41
Step 3 - Wire Up the Logic Port	4-41
Step 4 - Create a New Crosspoint	4-41

Caution!

Configuring the GIBRALTAR NETWORK Audio Router hardware is a detailed and complex process. Improper configuration changes may cause improper operation or disable previously operating functions. If done properly, configuration changes can be made while “on the air” without disruption, however it is always best to restrict configuration changes to time periods when an error could be tolerated. When in doubt, please, contact Wheatstone Technical Service to avoid any error in configuration changes.



GIBRALTAR Ethernet / IP Address Quick Start

Ethernet Cabling

- Use a CAT-5 *crossover* ethernet cable to connect a PC directly to the GIBRALTAR,
or
- Use a standard (non-crossover) CAT-5 ethernet cable to connect the GIBRALTAR to your network hub.

Default IP Address

The GIBRALTAR router (or the WHEATNET, if that is the main controller in your system) IP Address is set to 192.168.1.160 at the factory. In order to connect using the XPoint software, the PC must have a matching network prefix (i.e 192.168.1.xxx). If your PC’s current IP address does not match you must choose one of the following options:

- change the IP address of the PC running the XPoint software.
or
- change the IP address of the GIBRALTAR router.

Changing your PC’s IP Address

To set your PC’s IP address you must access the TCP/IP Properties form for the network adapter. The exact procedure depends on the specific version of Windows™ you are running. Generally speaking:

- Navigate to the *Settings • Control Panel • Network configuration* form.
- Highlight the TCP/IP line item for your PC’s ethernet adapter.
- Click the “Properties” button (the TCP/IP Properties form should open).
- Click “Specify an IP Address” (DHCP not supported).
- Enter an IP address in the range of 192.168.1.2 to 192.168.1.254 (excluding .160).
- Enter a Subnet Mask value of 255.255.255.0

When in doubt, check with your Windows™ documentation or network administrator for specific details on altering the network adapter’s TCP/IP properties.

Changing the GIBALTAR's IP Address

Changing the IP address of devices in the system requires the editing of a text file located on EACH CPU in the system. You will need a third party FTP application to be able to FTP to the router and any control surfaces you may have in the system. We recommend the freeware FTP client FileZilla. Windows Internet Explorer allows FTP, but in our experience it is not the best choice for this file maintenance application.

To change the IP address scheme, carefully follow the instructions in the *Configuring System IP Addresses* Appendix 1 at the back of this manual.

Configuring IP Address in XPoint Software

Next, start the XPoint application, log on as administrator (password=Admin), and navigate to the *Configure>System* menu item. The following form will appear.

The screenshot shows a window titled "Advanced Crosspoint Configuration" with a standard Windows-style title bar (minimize, maximize, close buttons). The window contains a "File" menu. Below the menu is a "Number Of Tiers" spin box with the value "1". Underneath is a "Tier Information" section with several fields: "Tier ID" (spin box with "1"), "Tier Name" (text box with "Tier1"), "IP Address" (four text boxes containing "192", "168", "1", and "160" respectively), and "Broadcast Port" (text box with "55555"). At the bottom of the window are "Apply" and "Cancel" buttons.

IMPORTANT NOTE!

This form tells the XPoint software where the Host CPU is located on the network. To modify the actual network settings of the Host CPU card located in the system's Master Rack - see *Configuring System IP Addresses* Appendix 1.

NOTE: When done, the Tier ID spin box must show the Tier number of the Tier that houses the main system CPU (usually Tier 1) or XPoint will not be able to connect to the system on startup.

Important:

- If you changed your PC's IP Address, enter the parameters exactly as displayed above.
- If you changed the GIBALTAR's IP Address, enter the parameters you changed via the XP_NET.TXT file edit.

If you are connected to the router, you should see a "Connecting to..." message in the status bar at the bottom of the screen.

Saving the GIBALTAR Configuration

Once you connect for the first time be sure to save the configuration. Choose the *File>Save* main menu option from the toolbar. When you make subsequent changes (e.g. rename Sources or Destinations, add controllers, etc.) be sure to save them.

XPoint Software Setup Guide

Getting Started

All Wheatstone GIBRALTAR NETWORK router hardware is pre-configured at the factory according to customer specifications. This approach greatly speeds the installation process, getting you “online” faster. You may not need to make any software configuration changes.

After installation and cabling of all required hardware, the system administrator may use the XPoint software to customize the remainder of the configuration. Before you begin, be sure you have an Ethernet connection between the XPoint computer and the Host CPU card. See the preceding CPU-2001 chapter for details.

The following sections will guide the user through all phases of the software configuration. The main items that may require attention are: any signal definition changes, source and destination signal naming, logic, XY controller mapping, and optional Wheatstone legacy console input channel mapping.

GUI Log-In

Once the XPoint software has been installed and started, a “Log In” dialog box will be displayed on the screen. There is one possible password protected log in identity that a user may log in as:

Administrator – Allows logged in user complete access to hardware configuration, signal naming, I/O crosspoint switching, and destination locking.

Once logged in as Administrator the GUI attempts to connect to the primary GIBRALTAR CPU or WHEATNET and downloads the current configuration and crosspoint status onto the PC. This may take 30 seconds or more. Check the lower left hand corner of the screen for connection status - wait until it says “Online” and the status box turns green.

Passwords

Default password is “Admin” for Administrator.

While in Admin mode you can change the password that is used to enter Admin mode. Select the *User/Change Password...* menu option to bring up the “Change Password” dialog box. Enter a password between 4 and 10 characters long in the “New Password:” text box, then re-enter the password in the “Verify Password:” text box. Click *OK* to change the password or *Cancel* to cancel the operation.



Connection Between the Configuration GUI and Master Rack

The Configuration GUI may be run in the OFF-LINE or ON-LINE mode. While OFF-LINE, the GUI does not communicate to the Host CPU in the master rack. This is useful to work through initial hardware and signal definitions, which may be downloaded later.

The GUI starts in ON-LINE mode. A TCP connection to the Host CPU is attempted, as indicated via the status message and yellow status indicator shown below.

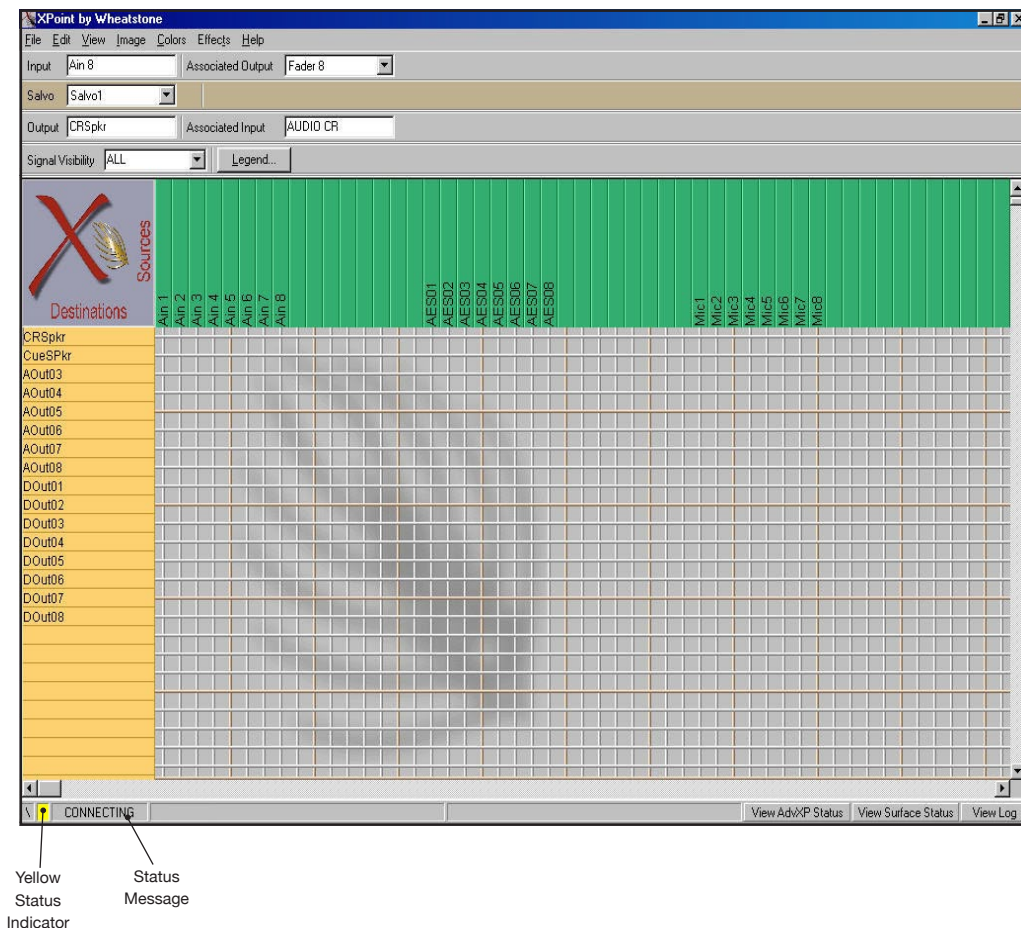

When the GUI successfully communicates with the Host CPU software it will start receiving the configuration that the Host CPU had stored in its nonvolatile memory. While downloading this configuration information the yellow status indicator turns green and the status message changes from CONNECTING to something similar to the following (varies with tier name and IP/address): “AdvXP: Downloading Config From 192.168.1.160 [Tier 1]”.

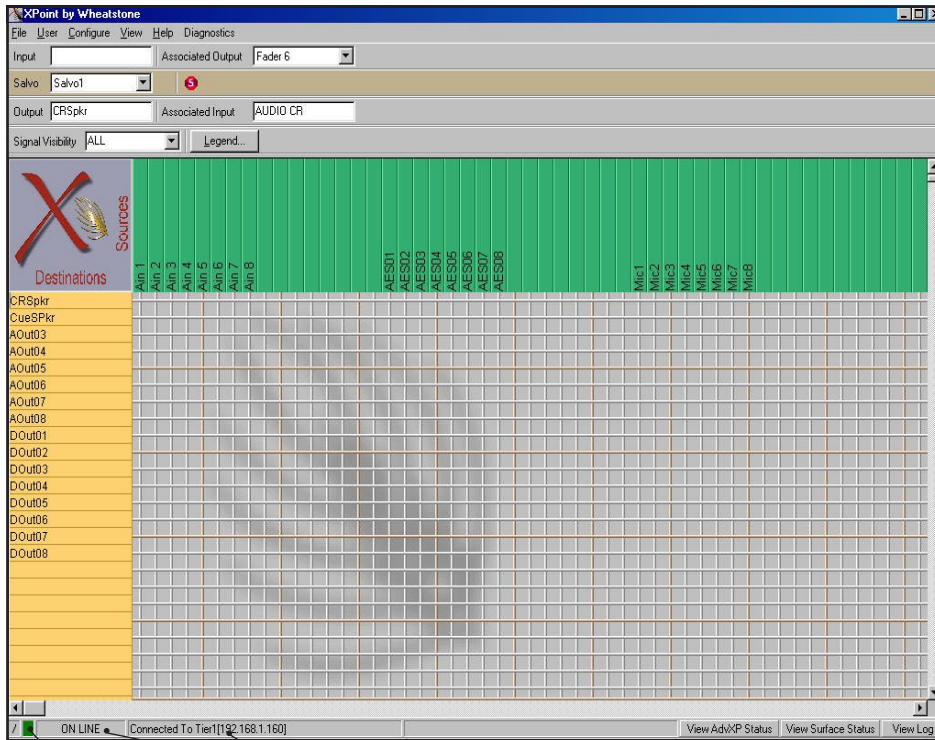

Green Status Indicator Status Message

Once the configuration has been downloaded the GUI enters the ON-LINE state as shown to the left.

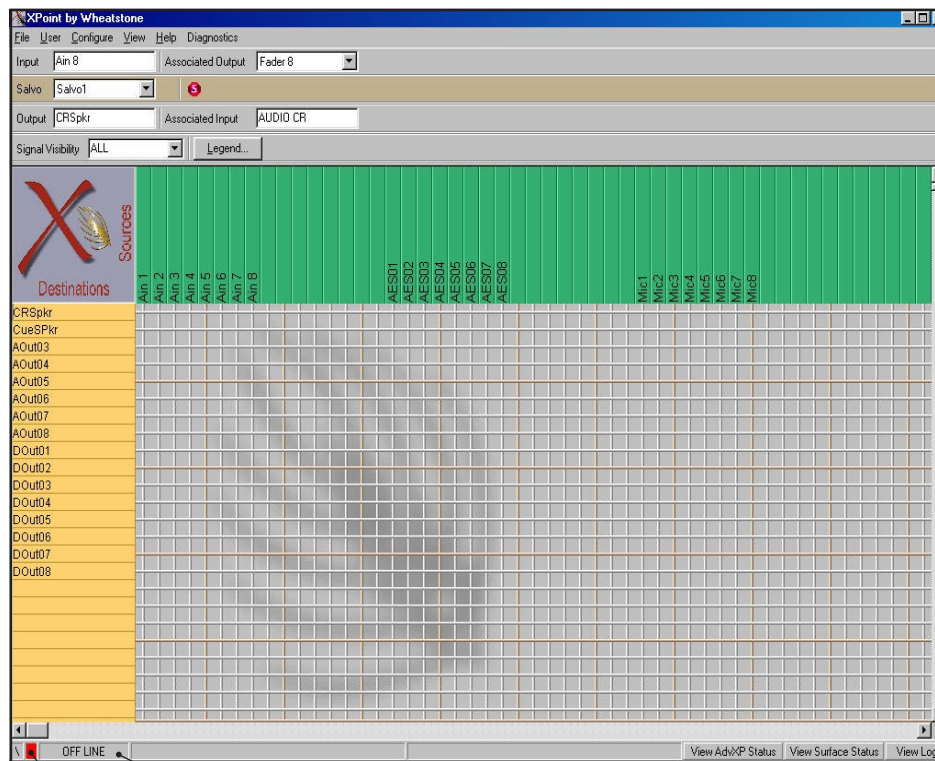

Red Status Indicator Status Message

To disconnect from the Host CPU and go to OFF-LINE mode, select the *View/Mode/Offline* menu option. The status indicator on the screen will then change as shown to the left.

To connect to the Host CPU while in OFF-LINE mode, select the *View/Mode/Online* menu option. The status indicator on the screen will then change to CONNECTING as discussed above.

If the user makes changes in OFF-LINE mode and then goes to ON-LINE mode, this message box pops-up:



Choose *Yes* to save OFF-LINE changes. The GIBALTAR software checks the request for validity (input to output, output not already assigned, lock flag not set, etc.). If the request is valid, it is implemented, and the Configuration GUI is updated. If not valid, the request is rejected with an appropriate reason message displayed.

There are three tabs, *View AdvXP Status*, *View Surface Status*, and *View Log*, on the bottom of the XPoint form to view router, control surface, and system error log status. A window like the following will appear when you click on the *View AdvXP Status* tab.

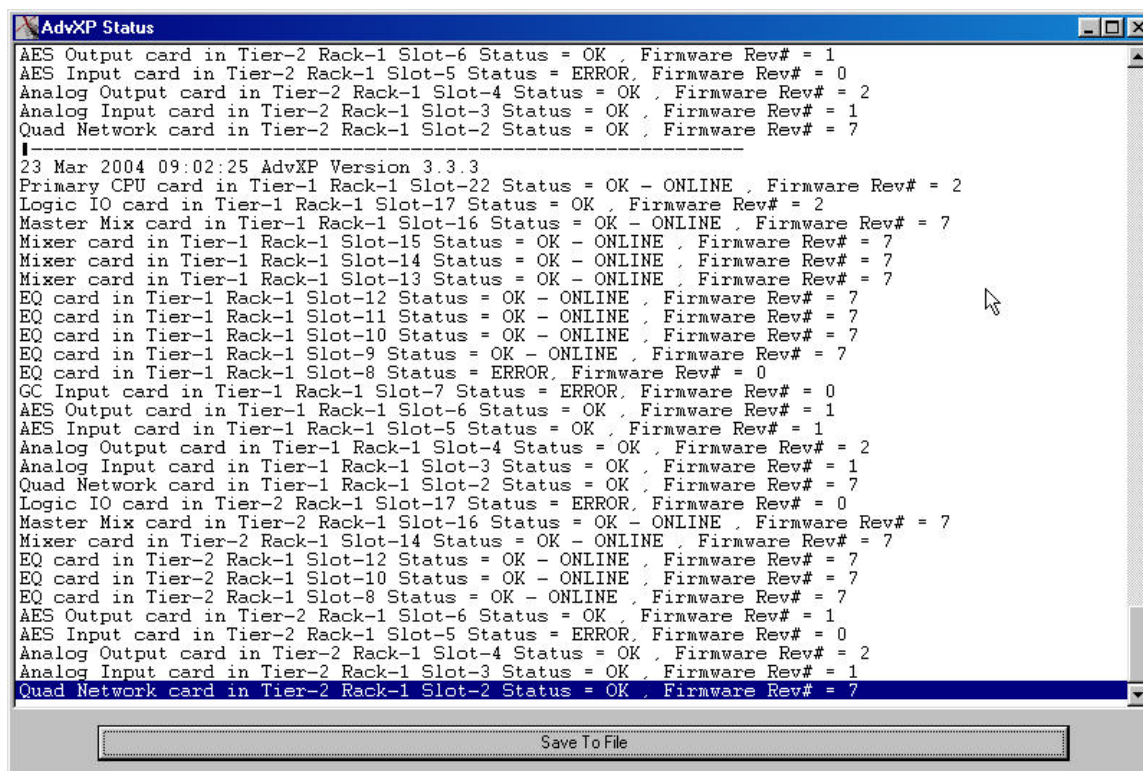

System Configuration Menus

From the user point of view, configuration of the GIBRALTAR system is relatively simple, since the XPoint GUI does much of the actual underlying configuration assignment work automatically. This section will outline a general procedure for customizing a GIBRALTAR system. A user logged in as “Administrator” has access to these configuration menus, but note that some fields are greyed out to prevent accidental changes to the configuration that would render the system inoperable or problematic.

Tier Configuration

Note that your system was pre-configured and this step is not necessary unless you have changed the IP address of a Host CPU-2001 card or Wheatnet.

The XPoint GUI is setup with some information regarding the number of Tiers in the system as well as the router’s Host CPU network parameters.

Selecting the *Configure/AdvXP Setup* menu option; the following Tier Configuration form appears.

IMPORTANT NOTE!
This form tells the XPoint software where the Host CPU is located on the network. To modify the actual network settings of the Host CPU card located in the system’s Master Rack - see Configuring System IP Addresses Appendix 1.

Use the Tier ID arrows to select Tiers. You can edit the Tier Name and IP Address fields. Only enter an IP address if the Tier has a CPU, enter 0.0.0.0 for all other Tiers. The IP Address value *must* match the current settings of the Host CPU in order to connect. The Number of Tiers in the system and the Broadcast Port settings cannot be changed. To change the IP address of the WHEATNET or GIBRALTAR CPU, see the “GIBRALTAR Ethernet/ IP Address Quick Start” at the beginning of this chapter, and Appendix 1.

After clicking the Apply button the GUI software will be in the “CONNECTING” state, as discussed in the previous section.

Be sure you leave this form with Tier ID: 1 selected, or you will not connect to the Primary WHEATNET or GIBRALTAR CPU.

NOTE: When done, the Tier ID spin box must show the Tier number of the Tier that houses the main system CPU (usually Tier 1) or XPoint will not be able to connect to the system on startup.

Control Surface Configuration

Note that your system was pre-configured and this step is not necessary unless you have changed the IP address of a surface.

Control Surface configuration is done by selecting the *Configure/Surface Setup* menu option; the following Surface Setup form appears.

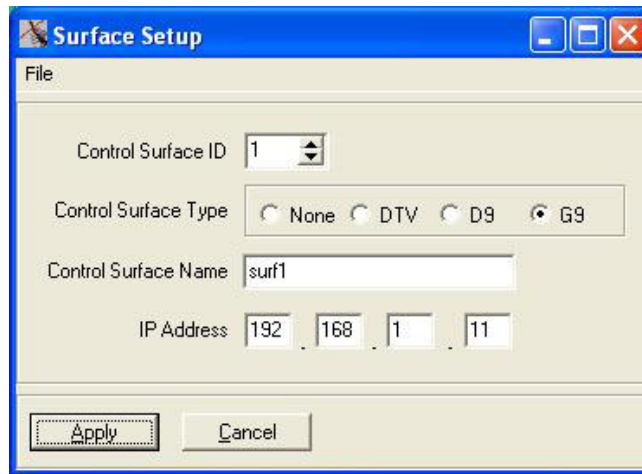

The screenshot shows a 'Surface Setup' dialog box with the following fields and controls:

- Control Surface ID:** A dropdown menu showing the value '1'.
- Control Surface Type:** A group box containing four radio buttons: 'None', 'DTV', 'D9', and 'G9'. The 'G9' radio button is selected.
- Control Surface Name:** A text input field containing the text 'surf1'.
- IP Address:** Four separate text input boxes containing the values '192', '168', '1', and '11' respectively, representing the IP address 192.168.1.11.
- Buttons:** 'Apply' and 'Cancel' buttons are located at the bottom of the dialog.

You can edit the Control Surface Name and IP Address fields. The IP Address value must match the current settings of the surface CPU in order to connect. See Appendix 1 for changing the IP Address on the surface CPU.

Rack Configuration

Note that your system was pre-configured and this step is not necessary unless you are changing or adding audio or logic hardware located in one or more racks.

Start up the XPoint GUI and log in to the software as Administrator. Select the *Configure/AdvXP/Rack Defs...* menu option. The following form appears.

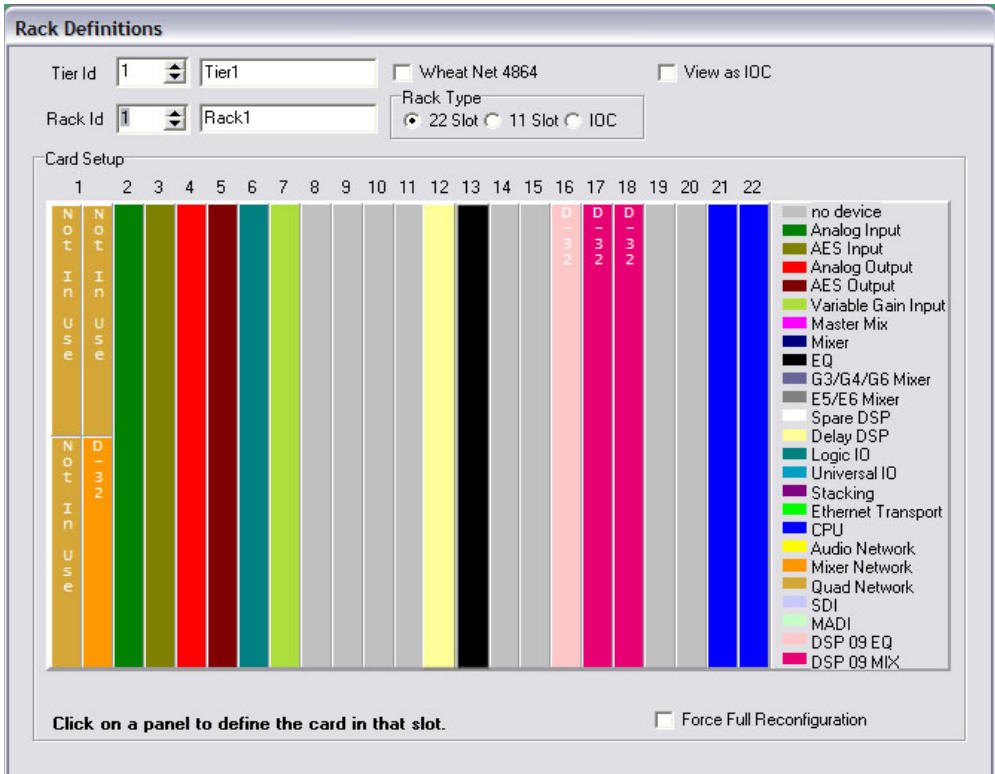

- Rack ID Notes:**
- The main rack is always Rack ID 1.
 - In some stacked systems, physical Rack #2 may equal Rack ID 3 or 4.
 - Audio Network satellite racks always begin at Rack ID 5.

If your Tier 1 controller is a WHEATNET, then this form will appear instead:

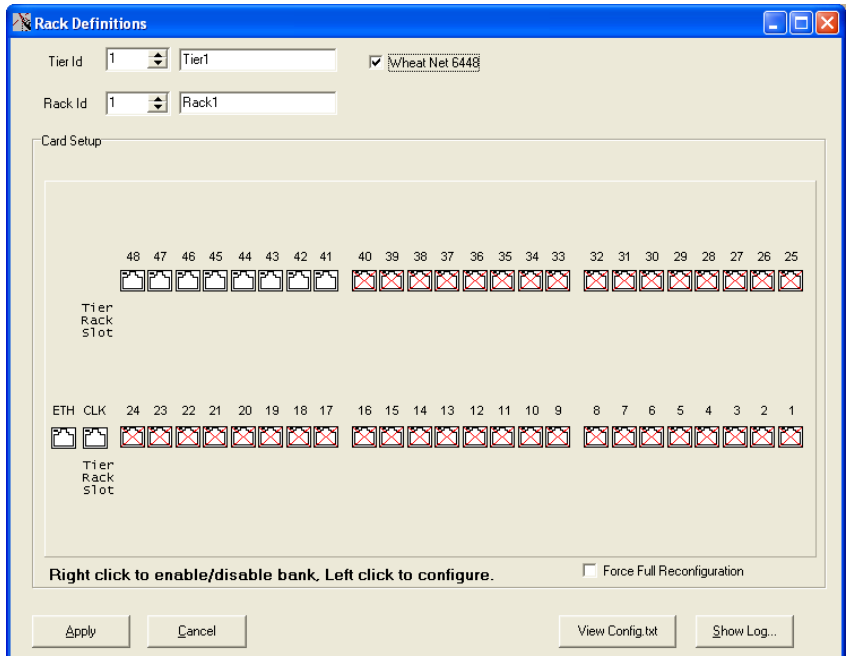

Adding a Card to a Rack



- Use the Tier ID and Rack ID spin-edit fields to select a rack in the system.
- Click on the appropriate slot in the rack to add a piece of hardware. A pop-up menu will appear with a list of available cards (e.g. Analog Input, AES Output, etc.).
- Click on a card type to install it in the chosen slot.

Reminder!
Save your changes...
Use the *File>Save* menu option.
Then *File>Send Cfg To Switch*.

Card/Signal Definitions

Note that your system was pre-configured and this step is not necessary unless you are changing or adding hardware located in one or more racks. If you only need to change the signal Name, see “Signal Definition” later in this section.

Some cards have hardware related settings that must be made when a card is installed. This is done via the *Card Definitions* form. To access this form, left click on an installed card in the Rack Definitions form, then press *Card Definitions* at the bottom of the popup menu.

Audio/Mixer/Quad Network Card Definition

This section is used by the factory to define Audio Network card properties. There are no user settings to configure here.

CPU Card Definition

This section is used by the factory to define CPU card properties. There are no user settings to configure here.

LIO Card Definition

The Card Definitions form for the LIO card is discussed in the section Configuring Triggered Port Logic (see page 4-26).

Mic and Variable Line Gain Card Definition

There are two different cards that use the Variable Gain Input type. The MIC-2001 Microphone Card provides gain variable mono mic channels, and the ADI-2001 Analog Input Card, when provided with variable gain firmware, provides gain variable stereo line channels. In each case the card is configured as a *Variable Gain Input*, but, depending on which card is used, the setup is different.

Left click on the *Variable Gain Input* slot in *Rack Definitions* to see the form shown on the right. Click on the *Card Definitions* button at the bottom of the card to bring up the following *Card Definitions* form:

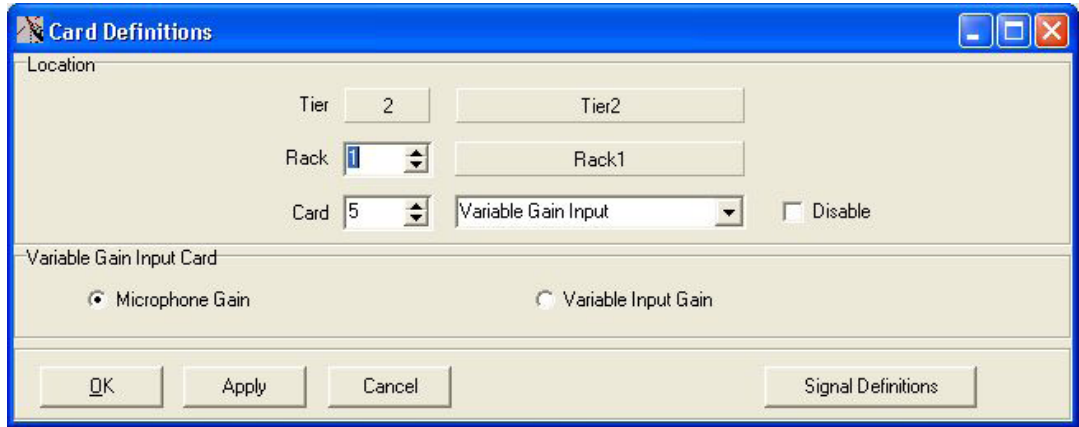

Notice the *Disable* checkbox. This allows you to block error messages in the GUI without having to remove the card from the configuration if the card has been removed for any reason. Checking this box when the card is present will not prevent the card from working, but will also block any error messages from the card if it isn't properly working. It is best to only check this box if you are removing the card physically from its slot on a temporary basis.

If the card is a MIC-2001 Card then the *Microphone Gain* radio button in the *Variable Gain Input Card* section of the form must be selected. But if the card is an ADI-2001 then the *Variable Input Gain* radio button must be selected instead.

In addition to setting the card type, variable gain signals must be set up to use gain control logic. As described below, MIC-2001 cards must use the **GainCtl1** function on each signal defined for the card. In the case of an ADI-2001 set up to be a variable gain card, the left side of each stereo signal needs to use the **GainCtl1** function and the right side of each stereo signal needs to use the **GainCtl2** function.

Once you first have the card set up properly as described above, you can click on the *Signal Definitions* button on the Variable Gain Card *Card Definitions* form and proceed with defining the signals and their associated gain control logic, as described next.

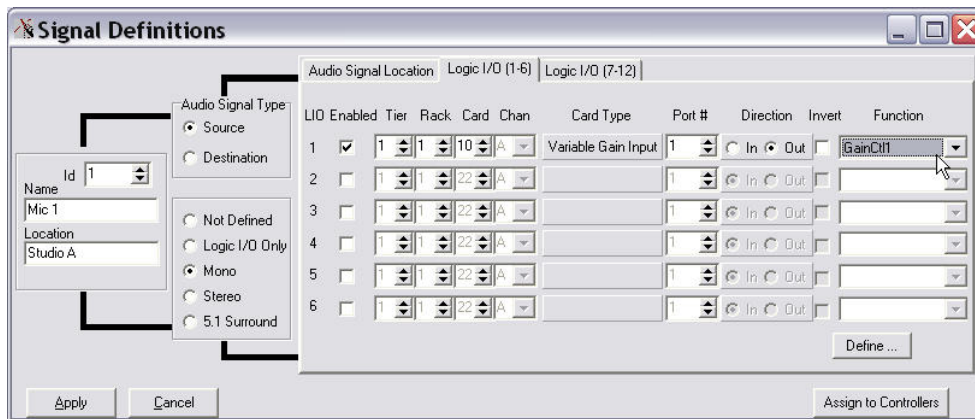

If creating new Mic signals, you must include the **GainCtl1** logic function for each new Mic signal to enable remote control of the pre-amp from a surface or XPoint GUI. If

you have an existing Mic signal, this step was already configured at the factory. Open the Modify Signal Definitions form and click on the Logic I/O (1-6) Tab. Notice how the signal has LIO 1 Enabled, the Location is exactly the same as on the Audio Tab, the Port is equal to the MIC input #, direction is OUT, and the Function is GainCtl1.

To add gain control logic to a new MIC signal:

- Open the Sig Defs form for the new MIC signal (right click on signal name)
- Click on Logic I/O (1-6) Tab
- Enable LIO #1
- Set the Location to the same Tier, Rack, and Card as the Audio Tab
- Set the Port # to the number of the input you are configuring
- Set the Direction to Output
- Set the Function to GainCtl1
- Repeat for all other new MIC signals

Follow a similar procedure when creating new variable line input signals. You will set up a Second LIO (#2) with the Function GainCtl2, to enable gain control of the right channel.

If you are setting up *alias* signals (described later) that are aliases of variable gain signals, the aliases must also have the gain control logic settings as described above.

Analog Card Definition

OUTPUT CARD

If the selected card is an output card the form on the right appears after left clicking on the card in the *Rack Definitions* form.

Click on the *Card Definitions* button to modify the output card parameters. The following form will appear:

The screenshot shows the 'Card Definitions' dialog box with the following settings:

- Location:** Tier: 2, Rack: 1, Card: 4, Function: Analog Output, Disable
- Duplicate Assignment:** Duplicate, Rack: [dropdown], Slot: [dropdown]
- Output Card:** Enable Mono Summing, Disable Mono Summing



The *Disable* checkbox works as previously discussed.

A duplicated output card will map the same output signals as the card it is duplicated from. The intent is that any signals routed to the original output card will automatically be routed to the duplicated output card, since both cards will recognize the command messages connecting their shared Output Block.

If a card has had the mono summing capability enabled in the hardware (see page 2-32) then selecting the *Enable Mono Summing* radio button in the *Output Card* section of the form will allow for mono summing when a stereo input signal is routed to a mono output signal. If mono summing has not been enabled in the hardware then the *Disable Mono Summing* radio button should be selected.

INPUT CARD

The only user definable setting for the input card is the Disable checkbox, as previously discussed.

Digital Card Definition

OUTPUT CARD

If the selected card is an output card the form on the right appears after left clicking on the card in the *Rack Definitions* form.

Click on the *Card Definitions* button to modify the output card parameters. The following form will appear:

The screenshot shows the 'Card Definitions' dialog box with the following fields and options:

- Location:** Tier (2), Rack (1), Card (8), AES Output (dropdown), and a Disable checkbox.
- Duplicate Assignment:** Duplicate, Rack (dropdown), Slot (dropdown).
- AES Output Card Type:** Three radio buttons: 16 audio wires (NO mono summing), 16 audio wires (WITH mono summing), and 32 audio wires (NO mono summing).
- Buttons: OK, Apply, Cancel, and Signal Definitions.

To the right of the dialog box is a list titled 'Card #8' containing the following items:

- no device
- Analog Input
- AES Input
- Analog Output
- AES Output
- Variable Gain Input
- Logic IO
- Universal IO
- G3/G4/G6 Mixer
- Master Mix
- Mixer
- EQ
- Spare DSP
- Stacking
- Ethernet Transport
- CPU
- Audio Network
- Mixer Network
- Quad Network

At the bottom of the list is a button labeled 'Card Definitions'.

The *Disable* and *Duplicate* checkboxes work as previously discussed.

The mono summing settings depend on whether the card is an 8- or a 16- output card. If an 8 output card has had the mono summing capability enabled in the hardware (see page 2-25) then selecting the *16 audio wires (WITH mono summing)* radio button in the *AES Output Card Type* section of the form will allow for mono summing as previously described. If mono summing has not been enabled in the hardware then the *16 audio wires (NO mono summing)* radio button should be selected.

For a 16 output card you must select *32 audio wires (NO mono summing)*.

INPUT CARD

The Card Definitions button allows configuring of the input card as follows:

The screenshot shows the 'Card Definitions' dialog box. It has a 'Location' section with 'Tier' set to 2, 'Rack' set to 1, and 'Card' set to 7. There are also text boxes for 'Tier2', 'Rack1', and 'AES Input'. A 'Disable' checkbox is present. The 'Input Card' section has two radio buttons: 'One TDM Available' (selected) and 'Two TDMs Available'. At the bottom, there are buttons for 'OK', 'Apply', 'Cancel', and 'Signal Definitions'.

Disable works as previously discussed.

Select *One TDM Available* in the *Input Card* section for the 8 input AES card, or *Two TDMs Available* for the 16 input AES card.

Viewing Defined Source & Destination Signals

The Card Properties form provides a way to quickly determine which signals have been mapped to a particular input or output card and if any spare audio channels are available.

Select the *Configure/AdvXP/Rack Defs* menu option to view a given rack. You may now query any input or output card by *right* clicking on its location. A form similar to the one on the right will be displayed showing all signal names associated with the card. Notice that there are 16 circuit numbers displayed, which correspond to the 16 physical audio channels available on the card. Mono signals will occupy 1 circuit, Stereo signals will occupy two circuits, 5.1 signals will occupy six circuits. Note that 5.1 signals may span across cards. The order of the signal components displayed (i.e. Left, Right, Center, etc.) always follows the configuration entered on the *Signal Definitions* form.

Configuration Rules

The following rules were applied when configuring the hardware (most are required to ensure proper clock connection between racks):

1. The first CPU in each tier must reside in Rack ID 1, Slot 16. A failover CPU may be placed in Slot 14 of Tier1 Rack 1 only.
2. Audio Network cards – QAT-2001 – are installed in Slot 1 first, then spill to the right to accommodate surface or audio bandwidth requirements.
3. Each Tier has a Rack 1, this is called the “Local Rack.” Tiers may have up to 11 “Remote” racks; their ID numbers are Rack 5-15. Racks 2-4 are no longer used. Audio Network card ports are assigned as required, but each Remote Rack must connect to the Tier’s local rack (no cascaded remote tiers are allowed).

The screenshot shows the 'Card Properties' dialog box. It has a table with two columns: 'Circuit #' and 'Signal'. The table contains 16 rows of data. At the bottom, there is an 'OK' button.

Circuit #	Signal
1	CD 1
2	CD 1
3	MIC 1
4	MIC 1
5	MIC 2
6	MIC 2
7	HOT LINE
8	HOT LINE
9	ZEPHYR
10	ZEPHYR
11	NEWS
12	NEWS
13	OFF AIR
14	OFF AIR
15	STUDIO A
16	STUDIO A

4. In WHEATNET configurations, Audio Network cards are used to connect each GIBRALTAR Tier to WHEATNET. The first Audio Network card must reside in Slot1. Port A connects to a pre-defined Primary WHEATNET port number; Port B must connect to the same port number on the Backup WHEATNET.
5. Extra bandwidth is accommodated by adding WHEATNET links to cages. Each shipped system is different, so check your documentation or the XPoint configuration for specific wiring details.

Completing the Configuration

When all hardware has been added in this manner, press *Apply* on the menu. The GUI will validate and complete the configuration. If any warnings or invalid entries have been made, the Configuration GUI will prompt the operator for corrections.

Saving Your Configuration

At this time you should also save the configuration file to your default location, by selecting *File/Save...* from the Main Menu. Next, send this configuration for permanent storage on the Host CPU card by selecting the *File/Send Cfg To Switch* menu option.

Config.txt File

Once a final configuration has been made (*Apply* button clicked), an ASCII file, called “config.txt,” containing all of the configuration details, is created in the default directory. Go to *File/Save...* to select a default directory. A message box, similar to the one shown below, appears notifying the operator that this file has been created.

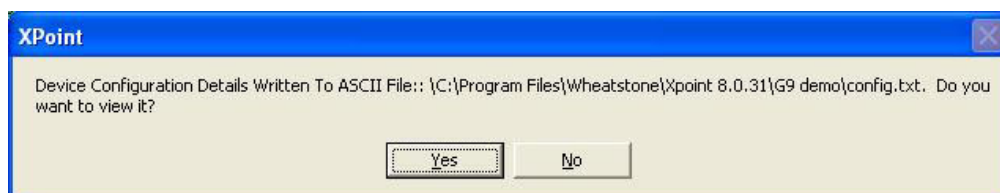

Using any text editor or word processor open this file to view the configuration listing. This document provides a listing of all configured hardware, including location, cabling, and jumpering details. A partial example of this listing is shown below:

Note: Slot/Rack ID's are 1-based.

Note: Slot ID #1 == Left-most slot in rack when looking at front of rack

Note: Do not map the serial ports of failover CPU's to devices. If a failover occurs, the CPU will use the same definitions used by the failed CPU.

Tier[1] Configuration::

Rack[1] used 9 of 32 TDM's

Rack[1] used 9 of 32 OB's (OB - Output Block)

Rack[1] Slot[3]= Analog Input

Diagnostics Info:: TDM used by this card = 4

Diagnostics Info:: Proxy TDM ID used by this card = 4

Rack[1] Slot[4]= Analog Input
 Diagnostics Info:: TDM used by this card = 3
 Diagnostics Info:: Proxy TDM ID used by this card = 3

Rack[1] Slot[6]= Analog Output
 Diagnostics Info:: OB used by this card = 4
 Diagnostics Info:: Proxy Block ID used by this card = 4
 Diagnostics Info:: hardwireTDM used by this card = -1

Rack[1] Slot[7]= Analog Output
 Diagnostics Info:: OB used by this card = 3
 Diagnostics Info:: Proxy Block ID used by this card = 3
 Diagnostics Info:: hardwireTDM used by this card = -1

Rack[1] Slot[8]= AES Input
 Diagnostics Info:: TDM used by this card = 2
 Diagnostics Info:: Proxy TDM ID used by this card = 2

Rack[1] Slot[9]= AES Input
 Diagnostics Info:: TDM used by this card = 1
 Diagnostics Info:: Proxy TDM ID used by this card = 1

Rack[1] Slot[11]= AES Input
 Diagnostics Info:: TDM used by this card = 0
 Diagnostics Info:: Proxy TDM ID used by this card = 0

Rack[1] Slot[13]= Audio Network
 multi-tier bandwidth = 64 Wires
 Must Connect to:
 Partner Tier ID* = 2
 Partner Rack ID* = 1
 Partner Slot ID* = 1
 COM PORT 1::
 VSB_1
 Master
 9600 (baud rate)
 COM PORT 2::
 Console Bus
 Slave
 9600 (baud rate)
 SW5-1 = OFF (Local)
 SW5-2 = ON (Primary)
 SW7[1,2,3,4] = 0000 (Rack ID) (0 = OFF, 1 = ON)
 Set SW5-3 as follows:: OFF=48Khz , ON=44.1 khz
 Set SW5-4 as follows:: OFF=fiber, ON=CAT5
 Diagnostics Info:: TDM used by this card = 5
 Diagnostics Info:: TDM used by this card = 6
 Diagnostics Info:: TDM used by this card = 7
 Diagnostics Info:: TDM used by this card = 8
 Diagnostics Info:: OB used by this card = 5
 Diagnostics Info:: OB used by this card = 6
 Diagnostics Info:: OB used by this card = 7
 Diagnostics Info:: OB used by this card = 8

*Location of Partner
 Audio Network Card
 that is connected to this
 Audio Network Card via
 a fiber or CAT-5 cable.

Rack[1] Slot[14]= AES Output

Diagnostics Info:: OB used by this card = 2

Diagnostics Info:: Proxy Block ID used by this card = 2

Diagnostics Info:: hardwireTDM used by this card = -1

Rack[1] Slot[15]= AES Output

Diagnostics Info:: OB used by this card = 1

Diagnostics Info:: Proxy Block ID used by this card = 1

Diagnostics Info:: hardwireTDM used by this card = -1

Rack[1] Slot[16]= AES Output

Diagnostics Info:: OB used by this card = 0

Diagnostics Info:: Proxy Block ID used by this card = 0

Diagnostics Info:: hardwireTDM used by this card = -1

Rack[1] Slot[22]= CPU

SW7[1,2,3,4] = 0000 (Rack ID) (0 = OFF, 1 = ON)

COM PORT 1::

XY Controller Bus

Slave

38400 (baud rate)

COM PORT 2::

XY Controller Bus

Slave

38400 (baud rate)

Signal Definition

Up to 2048 separate source and destination signals may be defined via the Configuration GUI. Signals 1-1000 are user signals. Surface signals by default start at 1000; some large systems may start earlier or later to accommodate installed hardware. To add or edit a signal from the GUI's main grid, *right* click on one of the Source or Destination signals and select "Modify Signal Definition." To define an input signal while in the *Configure/AdvXP/Rack Defs* form, click on an input card; for an analog input card press the *Signal Definitions* button, or, for a digital input card, first press the *Card Definitions* button, then, on the next dialog box, press the *Signal Definitions* button. To define an output signal while in the *Configure/AdvXP/Rack Defs* form, click on an output card, press the *Card Definitions* button, then on the next dialog box press the *Signal Definitions* button.

In each case the following form will appear.

Each signal is automatically assigned a unique Signal ID number. For each Signal ID number the following parameters can be configured:

- *Signal Name*: Enter the 8 Character name to be displayed on XY controllers and the XPoint GUI.
- *Location*: Enter an optional 8 Character description of the signal's location.
- *Audio Signal Type*: Choose Source or Destination.
- *Format*: Choose Logic I/O Only, Mono, Stereo, or 5.1 Surround.
- *Audio Signal Location Tab*: Defines the signal's physical location – Tier, Rack, Slot, Circuits.
- *Logic I/O Tab*: Maps up to twelve routable logic port signals to the current audio signal. Also used to define Logic I/O Only signals. See the "Configuring Logic I/O" section for details.

Most of these parameters are self explanatory. When defining the audio signal location, remember that XPoint *circuits* are equivalent to a single audio channel. Every audio card has eight stereo channels (8x2 channels = 16 circuits), except the Variable Gain Input, which has 8 mono channels.

Note that signals may be virtually mapped to locations that do not currently have appropriate hardware. These "virtual" signals exist in software, but may not be used until appropriate hardware is added to the defined locations. This feature allows a set of default signal names to be provided independent of hardware configuration.

Alias Signals

There is a special class of signals known as *alias* signals. Generally, the need for an alias arises when you have a signal that you sometimes want to treat as a stereo signal and sometimes want to treat as a pair of mono signals.

As an example, let's say you have a stereo pair from an analog output card wired to the stereo input of a computer sound card. Sometimes you are recording the air signal from a stereo program bus, but other times you want to feed the left side of the sound card with a mono bus and the right side with a mix-minus bus. With the pair defined as a stereo signal, you can't feed it from two mono Sources. But with the pair defined as two mono signals you can't feed it the left and right sides of a stereo Source.

Enter the alias. Let's say, to use actual numbers, that you have defined a stereo Destination named **Comp1** that maps to circuits 1 and 2 of the analog output card in Tier 1, Rack 1, Slot 5. The circuit 1 and 2 outputs are wired to a computer sound card stereo input. Now, find an area in the Destinations where you have a few blank spots. For example, you might have nothing defined for Destination signal IDs 55-62. Right click in the blank spot for ID 55 and select *Modify Signal Definition* from the popup menu. (You may have to change your Signal Visibility to "ALL" to see the unassigned signal IDs, or else you can right click in any Destination signal and change the *Id* spin dial to 55.) Now define a mono signal (let's name it **Comp1LT**) and map it to Tier 1, Rack 1, Slot 5, Circuit 1. Then click the *Id* spin dial's up arrow to move to ID 56. At this time you will see a message box warning you of a signal overlap and asking if you want to create an alias. Click *Yes*. Now, at ID 56, create another mono signal (**Comp1RT**) and map it to Tier 1, Rack 1, Slot 5, Circuit 1. Click *Apply*, then say *Yes* when asked again if you want to make an alias.

Now if you make a crosspoint between a stereo Source and **Comp1** (the original stereo Destination) the left side of the stereo Source will be routed to Circuit 1 of the output card and the right side of the stereo Source will be routed to Circuit 2 of the output card. On the other hand, if you make a crosspoint between one mono Source and **Comp1LT**, and a second mono Source and **Comp1RT**, then the first Source will show up on Circuit 1 and the second Source will show up on Circuit 2.

In addition to all of that, if mono summing is enabled on the output card, one or both of the Sources could be stereo, and the circuit in question would produce a mono sum of the Source.

You can make more than one alias of a signal, and the signal and its alias can both be stereo, both mono, or one of each. You can also make aliases of Sources as well as Destinations. The main rule to remember when using aliases is that the same circuit cannot be routed twice. In the above example, if you had a stereo Source routed to **Comp1** and proceeded to route a different Source to **Comp1LT**, then the original crosspoint to **Comp1** would be broken.

When you create an alias, the signal name will appear in red and italicized by default. You can change the appearance of the alias names by clicking on the *Legend* button that appears on the *Signal Visibility* tool bar (see the discussion of tool bars on page 4-37); the following form will appear:

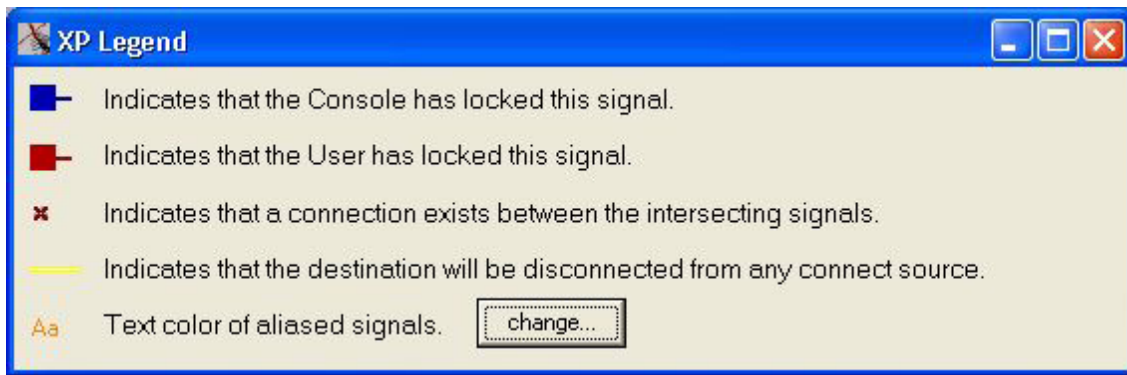

The main purpose of this frame is to explain the graphics embellishments in the signal matrix. But note the bottom line; here is shown the text color used to display aliased signal names. Click on the *change...* button to see a typical Windows™ color selection form. Select the color you want to use for aliases and click *OK*. The color of aliased signal text as displayed on the *Legend* form will change to the color you just selected. When you close the *Legend* form the text of any aliases you have already created will change to reflect the new color, and any new aliases you create will use the new color as well.

Configuring Logic I/O

Overview

The LIO-2001 adds 12 programmable logic input and 12 output functions per card. The addition of logic I/O adds a powerful level of complexity to your Wheatstone router and care must be exercised during configuration to ensure the proper results. It is important to understand that there are two primary ways to configure the physical logic ports in software – routable logic or triggered ports. Which type you choose depends on the particular application.

Routable Logic

Routable logic allows the user to make logic signal crosspoints in the same way audio crosspoints are made. Routable logic may be configured as independent “Logic I/O Only signals (e.g. switch inputs and solid state relay outputs); or up to 12 logic input or output signals may be mapped, or “piggybacked,” onto audio signals.

Independent “Logic I/O Only” logic signals may be cross connected just like audio signals. An external switch or relay closure wired to activate a logic input may be routed to control device A, B, C, etc., as required. The duration of the solid state relay output follows the duration of the input signal, thus allowing for latched or momentary applications. Logic I/O Only Sources are typically cross connected to Logic I/O Only Destinations, but mapped logic signals may be cross connected to independent logic signals as long as the assigned logic functions match.

Mapped logic signals enable the user to automatically route up to 12 logic signals along with an audio source. When an audio source is routed to a destination, all logic mapped to the source device is automatically routed to the destination device. The mapped logic I/O configuration greatly simplifies the management of control signals in a variety of scenarios including multi-recorder control, backup automation switch-over, and studio sharing applications.

Triggered Port Logic

Triggered port logic is a special class of logic I/O that uses a GPI or simple switch closure to fire a predefined Salvo or to make a temporary audio crosspoint. When a logic input port has been configured as a triggered port, the corresponding output port is dedicated as a tally-back function. Tally-back is provided as a means of confirming that the salvo has fired or the temporary audio crosspoint has been made. Triggered port logic is configured using the LIO Card Definitions form. Please see *Configuring Triggered Port Logic* later in this section.

Routable Logic Signal Definitions

There are two types of *routable* logic signals - Logic I/O Only or Mapped Logic I/O. All routable logic signals must first be defined using the Signal Definitions form. To add a new routable logic signal *right* click on a source or destination signal, then click *Modify Signal Definition* to open the *Signal Definitions* form. The following form should appear.

LIO Enabled	Tier	Rack	Card	Chan	Card Type	Port #	Direction	Invert	Function
<input checked="" type="checkbox"/>	1	1	10	A	Variable Gain Input	1	In Out	<input type="checkbox"/>	GainCtrl
<input type="checkbox"/>	1	1	22	A		1	In Out	<input type="checkbox"/>	
<input type="checkbox"/>	1	1	22	A		1	In Out	<input type="checkbox"/>	
<input type="checkbox"/>	1	1	22	A		1	In Out	<input type="checkbox"/>	
<input type="checkbox"/>	1	1	22	A		1	In Out	<input type="checkbox"/>	
<input type="checkbox"/>	1	1	22	A		1	In Out	<input type="checkbox"/>	

Click on either *Logic I/O* tab to view the logic parameters.

As with audio Sources and Destinations, each signal is automatically assigned a unique Signal ID number. For each Signal ID number, the following parameters can be configured:

- *Signal Name*: Enter 8 Character name displayed on controllers and XPoint GUI.
- *Location*: Enter optional 8 Character description of signal's location.
- *Audio Signal Type*: Source or Destination will already be selected.
- *Format*: Choose Logic I/O Only, Mono, Stereo or 5.1 Surround.
- *Audio Signal Location Tab*: Defines the audio signal's physical location – Tier, Rack, Slot, Circuits (*not used for Logic I/O Only signals*).
- *Logic I/O Tab*: Maps up to twelve routable logic port signals to the current signal.
 - *Enabled* – LIO#1 through #12, check to activate up to twelve LIO's.
 - *Tier, Rack & Card* – Identify physical location of logic card.
 - *Port#* - Choose one of 12 available physical ports.
 - *Direction* – *In or Out* – Selects input or output port type.
 - *Invert* – Flips the normalised port state (i.e. N.O. to N.C.).

Example – To add a single logic input function to a Source signal:

- Click on the LIO#1 Enabled checkbox.
- Select the logic card's physical location in a rack.
- Choose one of the twelve available logic ports on the card.
- Pick a direction; control outputs *from* a device connect to the logic card *input* ports, control inputs *to* a device connect to logic card *output* ports.
- Invert – Leave unchecked unless you need to change a port's normally open behavior.
- Function – Select a function name, e.g “Start”. Note that both the Source and Destination signals must have the same function names enabled in order to complete the circuit. Please see *Defining Routable Logic Functions* below for more information.

Defining Routable Logic Functions

Mapped logic and Logic I/O Only signals rely on common function names as a way of “knowing” which physical logic inputs need to control which physical logic outputs. When you map logic signals to an audio signal or create “logic only” signals using the Signal Definitions form, you must provide a *unique* logic Function for each LIO# enabled. When you make a crosspoint between a source and destination, the software checks the list of logic functions associated with the source against the list of logic functions associated with the destination and cross connects any logic signals with the same “Logic I/O Type” name.

Logic functions are created from the *Logic I/O Types* form. Up to 256 logic functions may be defined. First, open the *Signal Definitions* form by *right* clicking on a source or destination signal in the GUI’s main grid, then click on *Modify Signal Definitions*. Click on the *Logic I/O* tab, then click on the “*Define*” button in the lower right corner to open the *Logic I/O Types* form shown at the right. Note that many functions are predefined. In most cases you will not want to alter predefined functions. After the predefined you will find several generic functions with names like “LIO 120.” You may freely modify these generic functions as discussed below.

- *ID* – Static value from 1 to 256, cannot be changed. Use the up/down arrows to scroll to the desired function number.
- *Name* – Be sure to assign each function a unique name to avoid potential confusion when mapping logic functions. Names may be up to 8 characters long.
- *Precedence* – Always set to “Controller” for logic card applications. “Device” setting is reserved for future use.
- *Disconnected Output State* – Choose the desired state to leave the output in when this function is disconnected. Choices are OFF (open), ON (closed), or Current Value (last known state).

The screenshot shows the 'Logic I/O Types' dialog box. It has a title bar with a close button. Inside, there is a dropdown for 'Id' set to '1', a text field for 'Name' containing 'MachStrt', and two groups of radio buttons. The first group is 'Precedence' with 'Controller' selected and 'Device' unselected. The second group is 'Disconnected Output State' with 'OFF' selected, 'ON' unselected, and 'Current Value' unselected. At the bottom are 'Apply' and 'Cancel' buttons.

Viewing Defined Logic Signals

The “Logic IO Properties” form provides a way to quickly determine which logic signals have been assigned to a particular logic card and if any spare logic ports are available.

Select the *Configure/Rack Defs...* menu option to view a given rack. You may now query any logic card by *right* clicking on its location. A form similar to the one on the right will be displayed. The “Associated With XPoint” tab displays all mapped and routable logic signals on the card. The “Directly Triggered” tab displays all of the Triggered Port assignments on the card.

The screenshot shows the 'Logic IO Properties' dialog box, 'Directly Triggered' tab. It has a title bar with a close button. Below the title bar are two tabs: 'Associated With XPoint' and 'Directly Triggered'. The 'Directly Triggered' tab is active. It contains two tables: 'Input Ports' and 'Output Ports'. Each table has columns for 'XPoint Signal' and 'Function'. The 'Input Ports' table has 12 rows, with the first four rows containing 'CD 1' and 'RemOn', 'RemOff', 'RdyLED', and 'Cough' respectively. The 'Output Ports' table has 12 rows, with the first two rows containing 'CD 1' and 'MachStrt', and 'CD 1' and 'MachStop' respectively. An 'OK' button is at the bottom.

Input Ports		Output Ports			
XPoint Signal	Function	XPoint Signal	Function		
1	CD 1	RemOn	1	CD 1	MachStrt
2	CD 1	RemOff	2	CD 1	MachStop
3	CD 1	RdyLED	3		
4	CD 1	Cough	4		
5			5		
6			6		
7			7		
8			8		
9			9		
10			10		
11			11		
12			12		

Configuring Triggered Port Logic

Triggered logic ports enable the firing of salvos or temporary audio connections from a GPI or simple switch closure (the closure must act to apply a user-supplied DC voltage to the logic input – see page 2-66 for details). When an input is configured to be a triggered port, its corresponding output is automatically assigned to be a Tally-back. Configuration of Triggered ports is done through the *LIO Card Definitions* form.

To open the *LIO Card Definitions* form, log on as Administrator and navigate to the Main Menu item *Configure/Rack Defs*. Select the Tier and Rack location and *left* click on the logic card to be configured. Click on the “Card Definitions” button at the bottom of the *Card Type* form. The following Card Definitions form should be visible.

The “Location” section at the top of the form indicates the physical location of the LIO-2001 logic card. The “Triggered Port Assignments” section allows up to 12 pairs of logic input/output ports to be configured. Logic ports on this card which have already been configured as routable logic will appear to be grayed out.

The following form description includes parameters that may be configured:

- *Input Port* – Indicates which physical port is being configured.
- *Salvo* check boxes – Assigns input port to fire a salvo.
- *Salvo* – Use drop down list arrow to select a Salvo to be fired.
- *Temporary Connection* check boxes – Assigns logic input port to temporarily connect a source to a destination (also temporarily disconnects the current source).
- *In Signal* – Use the up/down scroll arrows to select the temporary source signal.
- *Out Signal* – Use the up/down scroll arrows to select the affected destination.
- *Port Sense (Edge)* – Choose “+” to trigger on a low-to-hi input transition, choose “-” to trigger on a hi-to-low input transition.
- *Output Port* – Indicates which physical port is used for Tally-back.
- *Invert Feedback State* checkbox – Flips the normally open behavior of the Tally-back output.

Once the Triggered Port Assignments have been defined, press the *Apply* button to complete the configuration. The “Logic I/O Only Signals” button is provided for convenience and opens the “Signal Definitions” form. This may be useful to quickly un-assign mapped logic ports, making them available for Triggered Port assignment.

The screenshot shows the 'Card Definitions' window. At the top, the 'Location' section includes fields for Tier (1), Rack (1), and Card (14). Below this is the 'Triggered Port Assignments' table with 12 rows. Each row has columns for Input Port, Salvo, Temporary Connection, In Signal, Out Signal, Port Sense (Edge), Output Port, and Invert Feedback State. Row 1 is checked for Salvo and has In Signal '1' and Out Signal '1'. Row 2 has Temporary Connection checked, In Signal '33', and Out Signal '8'. The 'Port Sense' column has '+' or '-' buttons. At the bottom are 'Apply', 'Cancel', and 'Logic I/O Only Signals' buttons.

Input Port	Salvo	Temporary Connection	In Signal	Out Signal	Port Sense (Edge)	Output Port	Invert Feedback State
1	<input checked="" type="checkbox"/>	<input type="checkbox"/>	1	1	+ -	1	<input type="checkbox"/>
2	<input type="checkbox"/>	<input checked="" type="checkbox"/>	33	8	+ -	2	<input checked="" type="checkbox"/>
3	<input type="checkbox"/>	<input type="checkbox"/>	1	1	+ -	3	<input type="checkbox"/>
4	<input type="checkbox"/>	<input type="checkbox"/>	1	1	+ -	4	<input type="checkbox"/>
5	<input type="checkbox"/>	<input type="checkbox"/>	1	1	+ -	5	<input type="checkbox"/>
6	<input type="checkbox"/>	<input type="checkbox"/>	1	1	+ -	6	<input type="checkbox"/>
7	<input type="checkbox"/>	<input type="checkbox"/>	1	1	+ -	7	<input type="checkbox"/>
8	<input type="checkbox"/>	<input type="checkbox"/>	1	1	+ -	8	<input type="checkbox"/>
9	<input type="checkbox"/>	<input type="checkbox"/>	1	1	+ -	9	<input type="checkbox"/>
10	<input type="checkbox"/>	<input type="checkbox"/>	1	1	+ -	10	<input type="checkbox"/>
11	<input type="checkbox"/>	<input type="checkbox"/>	1	1	+ -	11	<input type="checkbox"/>
12	<input type="checkbox"/>	<input type="checkbox"/>	1	1	+ -	12	<input type="checkbox"/>

Signal Locking

To lock a signal, *right* click on one of available output channels on the crosspoint grid and select “Lock Connection.”

That crosspoint output signal becomes locked as indicated by a red line through the signal on the GUI display and shown on the form below.

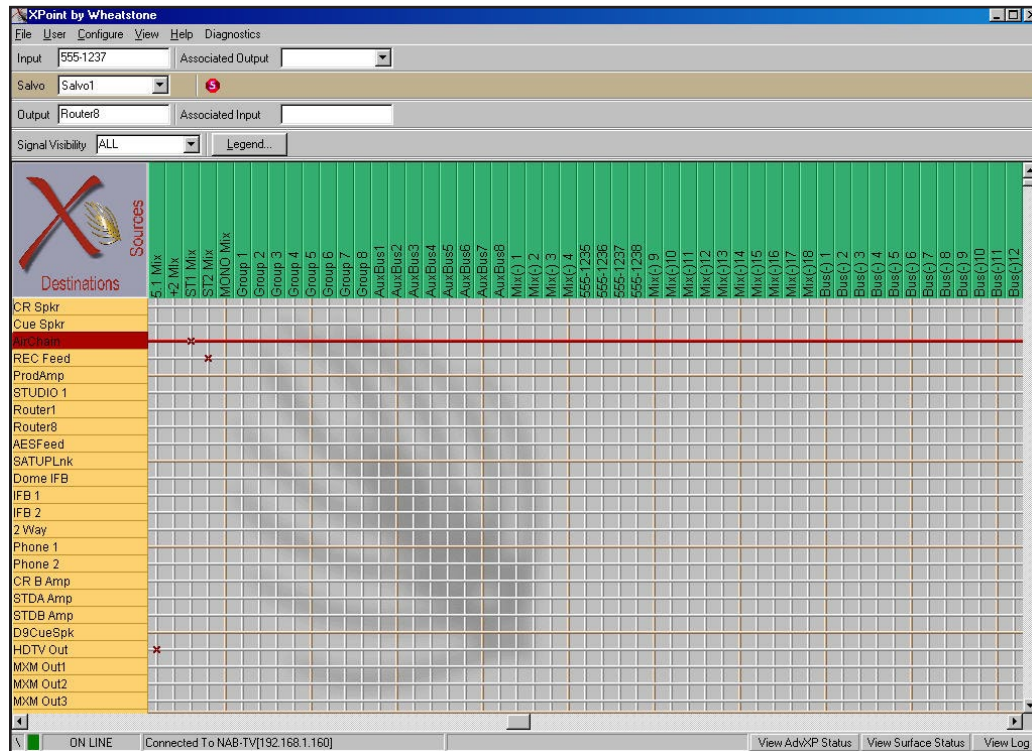

Note that you must be on line to lock a connection.

Salvo Definition

Macro control of the GIBALTAR router is accomplished by creating and firing Salvos. A Salvo is simply a group of cross connects, disconnects and “do nothings” that occur when the selected Salvo is fired. Each Salvo has a unique name and can be programmed to be visible to any hardware XY controller or XYC GUI.

To define a Salvo, use the Configuration GUI and enter *Salvo Edit Mode* by selecting the *View/Mode/Salvo Edit* menu. The operator may then choose to modify the grid connections in an existing Salvo, or use the Salvo toolbar icons to rename an existing Salvo or to create a new one. By making and breaking connections on the crosspoint grid, the operator builds up a Salvo definition. **The order in which Salvo actions are created determines the “playback” order.** It is important to disconnect a source routed to a destination signal that has logic attached *before* routing the source to a new destination to avoid illegal logic state conditions.

When completed, the operator leaves *Salvo Edit Mode*, at which point the newly defined Salvos are available for use. If the application is connected to a switch (ON-LINE mode) the new Salvo definitions are automatically sent to the switch. It is a good idea to save the newly created Salvos on the PC by choosing *File/Save...* from the main menu.

Note that clicking on the Delete Salvo icon in the Salvo Toolbar will initially delete all the connections defined in a Salvo; a subsequent click on this button will delete the Salvo from the Salvo list. This is a useful way to clear out an existing Salvo and then redefine the connections within that Salvo. To cancel changes made to a Salvo select *View/Mode/Cancel Salvo Edits* from the main menu.

An example of Salvo Edit mode is shown below.

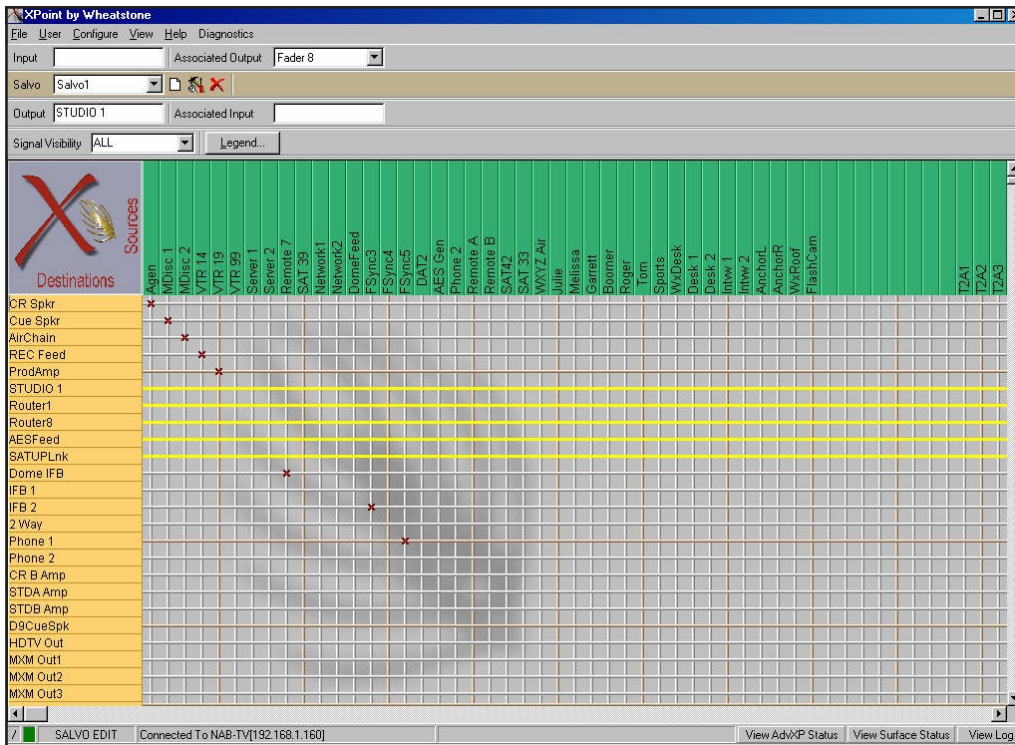

- <-Salvo Tool Bar
- Rename Salvo
 - New Salvo
 - Clear/Delete Salvo

Caution!
A yellow line through a connection means the connection will be switched OFF when the Salvo is fired.

Control Surface Configuration

Surface Visibility Settings

To view the control surface's visibility settings select *Configure/Any Wheatstone surface type)/Visibility Settings* menu option, which will display the form on the right.

By scrolling up and down in the *Control Surface Id* box, choose the appropriate control surface by its unique number. Then view or modify the settings for X Controller, Y Controller, XYC Source, XYC Destination, Caller, Studio, and Talkback (note, some surface types will have fewer tabs to choose from) by clicking on the appropriate tab. Note that all forms will be similar to that shown on the right, except the forms for the XYC Source and XYC Destinations will not have the *Apply Settings...*, *Save Subset* and *Apply Subset* buttons.

Next highlight the desired source signal(s) in the left column, then click on the single right arrow box (>) found between the columns. In order to make all signals visible click the double right arrow (>>) box found between the columns. The left arrow buttons are to remove signal(s) or salvo(s) from the visible list found in the right column. Clicking the *Apply* button will save the visibility options.

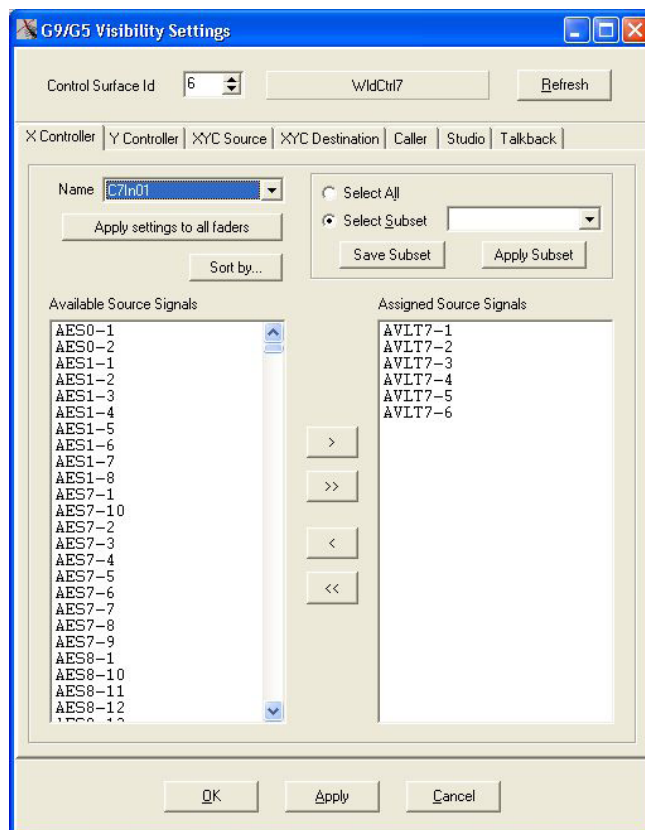

- *Sorting* – User may choose to sort the displayed signals according to Signal ID, Signal Name, or Signal Location.
- *Subsets* – User may create subsets of signals and apply the subset to individual inputs (EQs), studios, etc.
- *Apply settings to all faders* – This button takes the selected set of Assigned Source Signal and applies it to all of the selected control surface's input X Controllers. Similarly labeled buttons on other tabs work in a similar fashion.
- *Refresh* – When you click *OK* or *Apply*, you are sending visibility settings to all surfaces, not just the surface you are viewing. The settings sent to other surfaces depend on the settings saved in the current XPoint configuration. It is possible (through failure to save a configuration) for the current XPoint configuration visibility settings to be out of sync with the settings stored on individual surfaces. If you begin your visibility editing session by clicking the Refresh button, the current XPoint visibility settings are changed to agree with settings sent to XPoint from all surfaces. Doing this will prevent unwanted changes to visibility settings on other surfaces.

VDip Settings

To view or modify the Virtual Dip Switch Settings select the *Configure/VDip Settings* menu option, which will display the forms shown below. The content of the forms will vary depending on the surface type. The *Default* tab shows the default values for all signals unless specifically overridden. To override signals press the *Per Signal* tab, check the *Override Defaults* box, make your selections, and click the *OK* button to save your changes.

- *PFL/Cue Dropout* – When a channel’s CUE button is pressed it will assign the channel’s signal to the CUE bus. When *PFL/Cue Dropout* is checked it causes the channel’s CUE function to be de-activated whenever the channel ON switch is pressed.
- *EFS* – Will turn the channel OFF when the fader is moved all the way down and turn the channel ON when the fader moves from the full down position.
- *Fader Cue* – Will assign the signal to the Cue bus when the fader is moved all the way down.
- *UTL Pre Fader* – When checked will cause the signal assigned to the UTL output to be tapped before the fader.
- *UTL Pre On* – When checked will cause the signal assigned to the UTL output to be tapped before the channel ON/OFF switches.
- *Timer Restart* – The digital timer can be programmed to automatically reset to zero and begin counting up when the channel’s ON button pressed. To enable this function the *AUTO* button in the timer section has to be activated.
- *Machine Start Pulsed* – If this box is unchecked the Machine Start Logic will be a constant while the channel is on, just like an OnTally. If the box is checked the Machine Start Logic will be a short duration pulse.

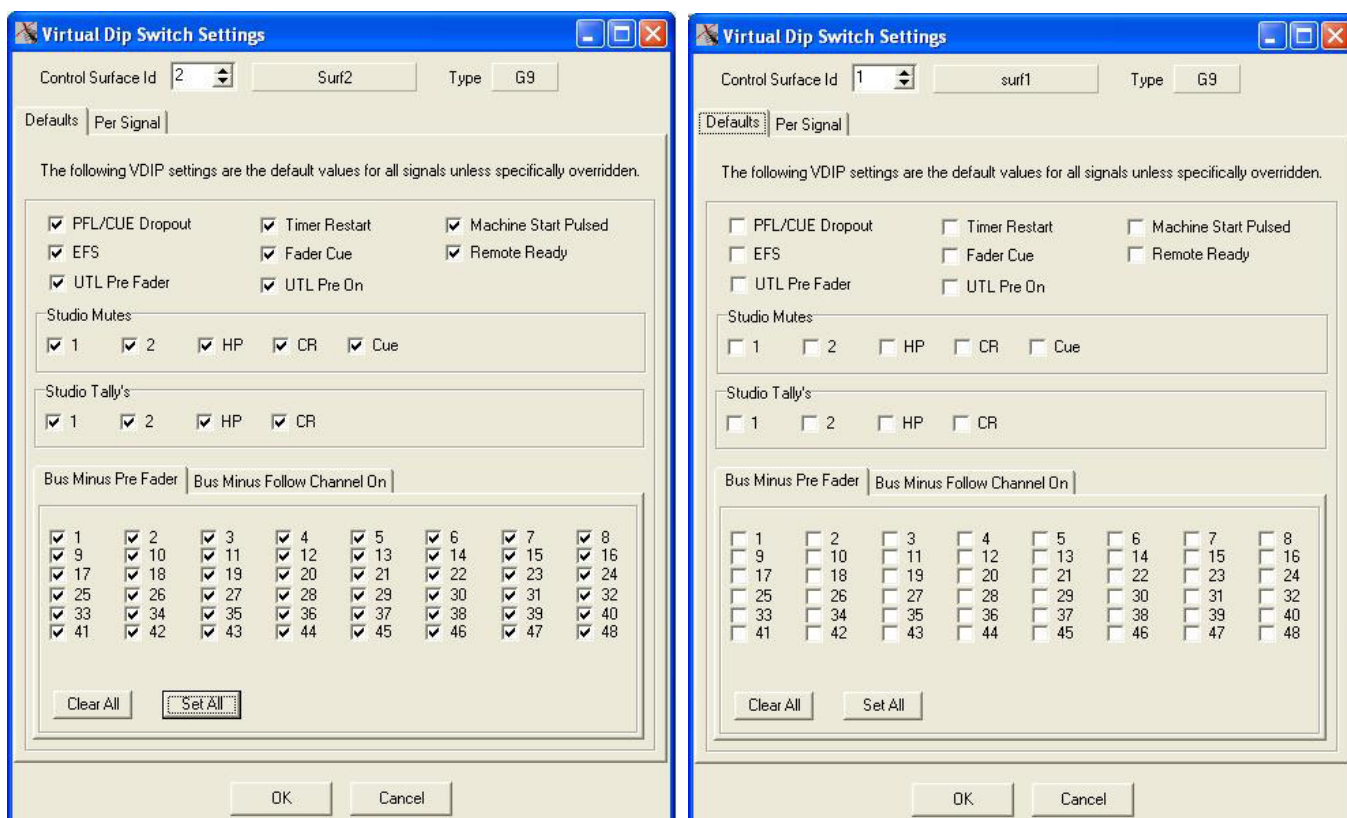

- *Remote Ready* – Will control the channel's OFF switch LED with an external source machine.
- *Studio Mutes* – Input channels can be programmed to mute the studio or cue speakers when the channel is ON. There are five studio mutes options shown (depends on the control surface type). Checked boxes show which speakers are muted.
- *Studio Tallies* – Turning the channel ON can activate a remote tally indicator. There are four tally control lines shown (depends on the control surface type): Tally 1, Tally 2, HP and CR (On-Air Tally). Checked boxes show which tallies are activated.
- *Bus Minus Pre Fader* - Sets the input signal sent to the Bus Minus system to be pre-fader. Not all surface types have a Bus Minus system.
- *Bus Minus Follow Channel On* - Sets the input signal sent to the Bus Minus system to follow the channel ON switch.

Line Gain

To view or modify the line input channel gain select the *Configure/Line Gain* menu option, which will display the form shown at the right.

Each control surface and input signal is identified via the *Control Surface Id* and *Input Signal Id* spin edit boxes. Define the line gain level and click the *OK* button.

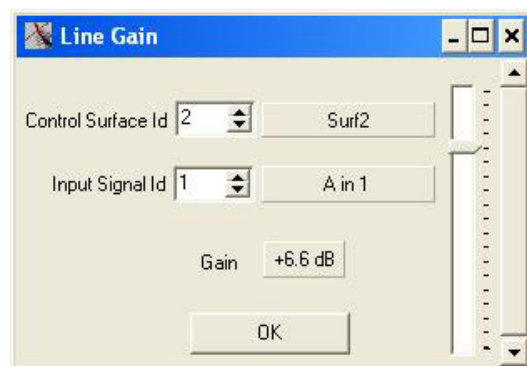

Microphone Gain

To view or modify the mic input channel gain select the *Configure/Microphone Gain* menu option, which will display the form shown at the right.

Use this control in systems that have mic input cards but do not have control surfaces with mic gain controls.



Mix Minus Polarity

To modify the mix-minus polarity select the *Configure/Mix Minus Polarity* menu option, which will display the form shown at the right.

- *Negative* – Preferred in Radio applications; requires users to assign each fader to a MXM bus.
- *Positive* – Preferred in TV applications; users simply press a single MXM switch to subtract the fader from the MXM bus.

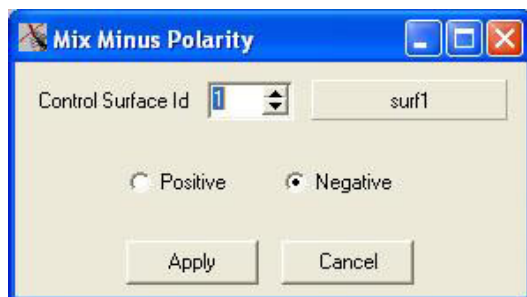

Password Modes

To change the password used to enter a control mode on the surface, select the *Configure/Passwords* menu option, which will display the form shown at the right. The available modes are:

- Admin – Allows access to all surface functions.
- User – Allows a limited set of user functions, programmable on a surface by surface basis in XPoint software. Navigate to XPoint menu choice *Configure/Passwords* and select the *User Privileges* button to setup user level privileges; this will display the *Setup User Level Privileges* dialog box as shown to the right.
- Guest – Blocks out MXM level, MXM assigns, Event takes, and visibility changes from the surface.

Depending on the surface type, default passwords may have been assigned. Check the form to determine if this is so.

If you remove a password entry from the Surface Passwords dialog box and leave the box empty, you will be able to enter that mode on the surface without needing a password.

In multiple surface installation, use the *Refresh* button before changing surface passwords to insure that you don't inadvertently change passwords on another surface due to your current XPoint configuration being out of sync with the surface settings.

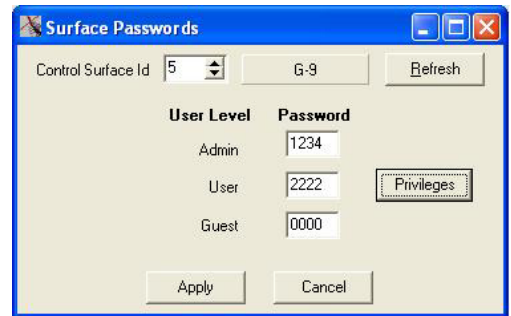

Programmable Buttons

The control surface's programmable buttons can be used in different ways.

If you want a button to fire a Salvo or make a temporary crosspoint, select the *Configure/Spare Button LIOS* menu, which will display the form shown at the right. To program a button to fire a Salvo, check the box immediately to the right of the Spare Button number, then select a Salvo from the pulldown list under Fire Salvo. The Salvo will fire whenever the programmed button is pressed.

To cause the button to make a temporary crosspoint, check the box to the right of the word "or" on the same line as the desired button number, then select the desired Source and Destination Signals for the temporary crosspoint. For example, let's say you program button 3 to temporarily connect a source

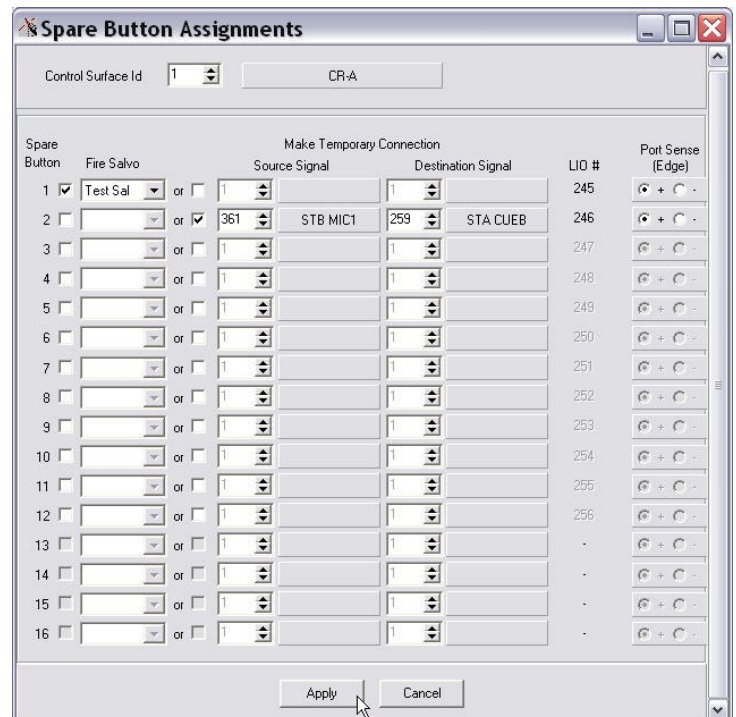

named “OUT 1” to a destination named “IN 1.” As long as you are holding button 3 down, OUT 1 will feed IN 1. If a different signal was feeding IN 1 to start, that connection will disappear while the button is pressed and reappear when the button is released.

You can also control a physical logic output with a programmable button. When the system is originally created, two or three signals will be auto-generated to enable programmable button use: GxxSPAR1 is associated with buttons 1-6, and GxxSPAR2 is associated with buttons 7-12, and GxxSPAR3 is associated with buttons 13-16. If you look at the signal definitions of these signals, you will find that function names are assigned to them. You need to create a physical Logic Only destination (see page 4-23 for details), such as LOut1, and use the same function name for that destination as is used for the programmable button that will control it. Assuming for the moment you are working with button 1, the last step is to make a crosspoint on the XPoint grid to connect GxxSPAR1 (remember, it deals with buttons 1-6) and your Logic Only destination (in this case, LOut1). The combination of the crosspoint and the matching function names causes the specified logic output port to respond to button 1.

In a similar manner the LEDs that light up the programmable buttons can be controlled by physical logic inputs. Once again you create a physical Logic Only destination, map a source signal to the programmable button signal by function name, and make the crosspoint connection in XPoint.

Note: The “xx” part of the signal name is usually the surface number in a multi surface system. These signals are located in the horizontal Sources set of signals and are typically in the signal space above signal ID 1000 of the XPoint grid.

Special Functions – Console Locks

If a crosspoint output signal is mapped to a console module and that module is “ON AIR,” that crosspoint output signal becomes console-locked, as indicated by a blue line through the signal on the GUI display. When a signal is console-locked its connection to a crosspoint input cannot be changed. To change this connection, take the module “OFF AIR” and then choose a different source.

Whenever a signal is removed from the console map, any “ON-AIR” locks are automatically removed. This prevents a console-lock from being “stuck on” with no way to remove it.

Console Presets

If a console has the ability to save a Preset, the switch software will save the current connection information for all output signals that are currently mapped to that console. The next time that console activates that preset the connections that existed at the time the preset was saved are restored. However, if a module is ON-AIR when the Preset is taken, that connection will not be made. This ensures that activating a preset will not disturb any ON-AIR signals.

If the user changes the crosspoint-output-signal-to-console mapping, the Presets for that console may be invalidated. The user should go through and re-save the presets on that console after changing the console map!

You can set surface programmable buttons (*aka* spare buttons) to take presets. The first step is to edit the surface xx_OPTS.TXT file to allow the spare buttons this capability. See the manual for the particular surface type you are dealing with, in the Appendix under the topic Options Text File. Briefly, you will make the appropriate SPARE OPTIONS selection for each button you want to have take a preset. Notice that availability of this option depends on the surface type.

Once you have enabled a spare button to take presets, you then have to map the button and the preset. Select the *Configure/Surface Presets* menu, which will display the form at the right. Select the desired surface in your system by dialing it up in the *Control Surface Id* spin dial. If you suspect that your XPoint configuration may be out of sync with any surface in the system, click the *Refresh* button to avoid undesired changing of other surfaces as you go through this procedure.

The left *Spare Buttons* column of the *Surface Preset Setup* form will allow you to assign a preset to a spare button. Please note, choices will be grayed out for buttons that have not been programmed via the surface options text file to allow preset takes. For any button that has been programmed to allow preset takes, you can choose the desired preset from the drop down box for that button.

Presets can also be fired with external logic signals. The procedure for this is a bit different. There is a surface auto-generated Source called xxPRST, where xx refers to the particular surface in a system. This signal must be cross-connected to a Logic I/O Only Destination (see earlier discussions on creating Logic I/O Only signals) mapped to the logic input port you will use to fire the preset, and further mapped by Function (typically *Preset01* through *Preset12*).

The same *Surface Preset Setup* form just displayed for firing presets with the spare buttons is used to map actual presets to the Function. For example, say you have a preset named *My_Preset*, and you want to fire this from a logic port. To map this particular preset to the *Preset01* Function, select *My_Preset* in the drop down box at the right side of the form, under *Logic IOs*, on the first line. The second line would map a named preset to the *Preset02* Function, and so on. A preset must be defined before its name will show up in the drop down box.

Once properly set up, a logic closure applied to the selected port will fire the desired preset.

Spare Buttons	Logic IOs
1: None	1: PROG#001
2: None	2: PROG#002
3: None	3: None
4: None	4: None
5: None	5: None
6: None	6: None
7: None	7: None
8: None	8: None
9: None	9: None
10: None	10: None
11: None	11: None
12: None	12: None
13:	13:
14:	14:
15:	15:
16:	16:

Tool Bars

Between the XPoint Menu Bar and the XPoint switch matrix diagram there are four tool bars that can be made visible, as shown here:

The four tool bars are *Input*, *Salvo*, *Output*, and *Signal Visibility*. Each one can be enabled from the *View/Tools* menu. A tool bar will be visible if its name has a check mark in front of it in the menu.

The *Salvo* tool bar is used to manage salvos, and has already been discussed (see page 4-27).

The *Input* tool bar is used to quickly see the Destination(s) a given Source

is connected to. Mouse over the green box in the Sources area that contains the name of the Source in question. The *Associated Output* box on the *Input* tool bar shows the first Destination that the Source is connected to. To see the names of any other Destinations the Source is feeding, move the mouse straight up, staying within the boundary of the Source name box until the mouse is above the Source name area. Then move the mouse to the drop down arrow at the end of the *Associated Output* drop down box and click the arrow to see the complete list.

The *Output* tool bar has a function similar to that of the *Input* tool bar. Mouse over the yellow box in the Destinations area that contains the name of the Destination of interest. The *Associated Input* box will show the name of the Source that the Destination is connected to. Since only one Source can be connected to any given Destination, there is only one *Associated Input* shown for a particular *Output*.

The *Signal Visibility* tool bar is very useful in limiting the number of Sources and Destinations that you see in the crosspoint matrix. This can often make finding a particular signal you're looking for much easier. Typical factory configuration will include separate visibility settings for each surface and for each tier, plus it will include the following choices:

ALL – With this setting you will see a box for every possible Source and Destination in the system whether or not there is a signal defined for that ID. This is handy when you want to find an unused signal ID to create a new signal.

ALL - defined – With this setting you will see a box for every Source and Destination ID that has had a signal defined for it.

You may or may not see the *Filters...* button on the *Signal Visibility* tool bar. If it is not displayed, you can display it by editing the **XP.ini** file in the XPoint install directory. If you used the default installation paths, the XPoint directory can be found at **C:\Program Files\Wheatstone\XPoint**. Within this directory there is a file named **XP.ini**. If you have Windows set up to not display common file extensions the **.ini** portion of the file name will not be showing, but it can be distinguished from the actual XPoint program file, **XP.exe**, both by its size (the **.ini** file is much smaller than the **.exe** file) and the additional file type display of *Configuration Settings* (as opposed to the **.exe** file, which is an *Application*).

Although you can open and make changes to **XP.ini** while XPoint is running, you cannot save changes. So, if XPoint is running, you must exit from it before editing **XP.ini**.



To edit the file, double click its icon. The file will open in your default text editor. Scroll down to the bottom section, which is distinguished by the heading [Misc]. Within that section there should be a line that looks like this: `SignalFiltersEnabled=0`

Change the last character of the line so that it now reads: `SignalFiltersEnabled=1`

Save the file and close it. If the above text line does not appear in the file, add it somewhere within the [Misc] section.

Now, with XPoint running and the *Signal Visibility* tool bar displayed, you should see the *Filters...* button. Click it to display the following form:

To create a new filter, click the *New...* button. In the *Edit Filter Name* popup, type a name that describes the signals you want to see. For our example, we will call our filter **Logic Signals Only**. Click *OK* to accept the new name, and you will see that name appear in the *Filter* drop down box on the form.

As the name implies, we are going to build a filter that shows us all of the Logic I/O Only signals that have been defined for the system, but no other signals. If you are following along with this example you will want to have at least a couple of Logic I/O Only signals defined to test the resulting filter.

Put a check mark in the *by Attribute* check box. The form will expand to show the various attributes you can filter by. At this point the area at the upper right of the form will show that your filter selects exactly 0 Sources and the same number of Destinations, since you haven't selected any particular attributes. *Router* and *Router Interconnect* attributes apply to third party router signals, which are described in detail in the documentation that accompanies the Wheatstone Translator application. The *AOIP* attribute applies to AoIP signals, which are described in detail in the documentation that accompanies AoIP additions to the system. The rest of the choices are self-explanatory.

To continue our example, put a check mark in the *LIO Only* check box. The area at the upper right will now show how many Sources and Destinations that the filter will display. Assuming you have some Logic I/O Only signals defined, these numbers will be non-zero. Please note that any surface related auto-generated signals that are Logic I/O Only are included in the count.

Now click *OK* at the bottom of the form. On the *Signal Visibility* tool bar, click the arrow in the drop down box, find your new filter (it will show up in the list as **Filter - Logic Signals Only**, although it may be truncated to fit the box field size), and select it. You should now see only the Logic I/O Only signals you have defined, plus any surface Logic I/O Only signals. If you don't see any (in which case you should have seen 0 in the area at the upper right when you were done defining the filter) create one or two now to verify for yourself that the concept works.

Go ahead an experiment with the various filter settings to see how they work.

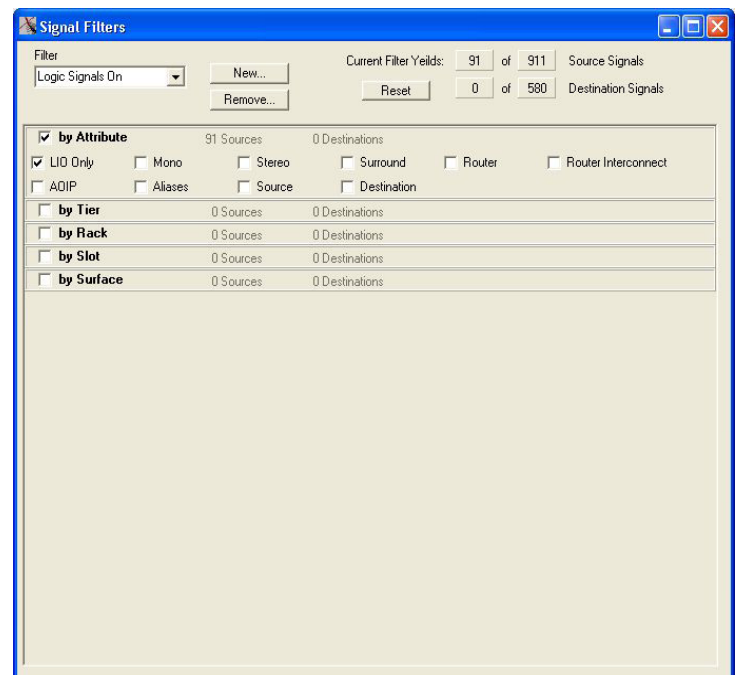

Main Menu Summary

The following is a summary of all the available menu choices when logged into XPoint as the Administrator.

File Menu

Open: Opens the *Load Configuration* form to load previously saved configuration elements for off-line viewing/editing or download to Host CPU.

Save: Opens the *Save Configuration* form to save any or all changes.

Send Cfg To Switch: Initiates download of currently loaded configuration to WHEATNET or the Host CPU module. Use this to update the system hardware with config changes.

Send Cfg To [xx] Surface: Initiates download of currently loaded configuration to the control surface. Use this to update the system hardware with config changes. You can select individual surfaces or update all surfaces at once. Note that the surface type will be displayed where [xx] is.

Request Cfg From Switch: Request the current configuration from WHEATNET or Host CPU.

Request Cfg From [xx] Surface: Request the current configuration from individual surfaces or all control surfaces of this type. Note that the surface type will be displayed where [xx] is.

Export Signals: Export signal names to a comma separated format suitable for spreadsheet input.

Exit: Exits the XPoint program.

User Menu

LogIn/LogOut: Opens the *XPoint Log-in* form if currently logged out, else logs out if logged in.

Change Password: Allows the Administrator to change the XYC or Admin access level Log-in passwords.

Configure Menu

AdvXP Setup: Configure tier, TCP/IP network, and Host port parameters.

Surface Setup: Configure surface type, name, and TCP/IP info.

AdvXP

Rack Defs: Define installed hardware parameters on a rack by rack basis. Allows user to view, define, and configure all installed cage hardware.

XY Controller Configuration: Used to define and configure hardware based (RS-485) XY controllers present in the system. Access XYC *Signal Visibility* editing here. Ethernet Controllers use a separate application (WSNetServer) for visibility.

Wheatstone Control Surfaces (wide variety types)

Visibility Settings: Define input and output signal availability

VDip Settings: Define muting, tally, and other surface behavior.

Surface Presets: Map Surface Presets for remote “TAKE” from a logic port.

Line Gain: Make gain adjustments on line inputs.

Microphone Gain: Make gain adjustments and enable/disable phantom power on mic inputs.

Mix Minus Polarity: Set additive or subtractive mode.

Passwords: Configure surface passwords.

Spare Button LIOs: Configure surface spare buttons to Fire Salvos or make Temporary crosspoints.

View Menu

Mode-Offline: Select OFFLINE to edit configuration. Be sure to Save configuration prior to returning ONLINE. This menu option is only available if you are currently ON LINE.

Mode-Online: Initiates network connection to Host CPU, uploads Host configuration once connected. View real time status of all crosspoints. This menu option is only available if you are currently OFF LINE.

Mode-Salvo Edit: Create, define and edit Salvos in this mode. This menu option is only available if you are not in Salvo Edit mode.

Mode-Leave Salvo Edit: Mode Exit Salvo Edit mode. This menu option is only available if you are in Salvo Edit mode.

Mode-Cancel Salvo Edits: Cancels any edits made in Salvo Edit mode and exits Salvo Edit mode. This menu option is only available if you are in Salvo Edit mode.

Tools-Inputs: Toggles visibility of the Input toolbar.

Tools-Salvo: Toggles visibility of the Salvo toolbar.

Tools-Outputs: Toggles visibility of the Output toolbar.

Tools-Signal Visibility: Toggles visibility of the Signal Visibility (XPoint Grid) toolbar.

Zoom 1x-2x-3x: Zoom in and out of XPoint grid.

Help Menu

How To...: Opens help hints text file.

About: Shows XPoint software revision.

Diagnostics Menu

View TCP Connection Status: Opens window displaying TCP/IP connection status for the router and all surfaces.

View System Health: Status opens a probe that monitors Audio Transport, Mixer Links, and Ethernet connection links between cages, surfaces, and WHEATNET. This form is not real time and can take up to two minutes or so to be fully up to date.

View UDP Log: Opens a form to enable auto logging. Can automatically save logs to files for technical support purposes.

Reset Switch: Performs a soft boot on the ONLINE Host CPU or WHEATNET. Failover will occur in redundant systems. In non-redundant systems the Host CPU or WHEATNET will get its configuration from the XPoint default configuration folder. Make sure you save changes to the configuration every time you made them!

System Integrity Check: Provides a set of three buttons to check validity of router, surface, and logic configurations.

The following buttons are located on the bottom of the main XPoint form.

View AdvXP Status : Lists all active installed hardware, card firmware revisions.

View Surface Status : Lists all active installed surfaces' hardware.

View Log: Opens Activity Log.

Right click on any log to enable/disable various levels of reporting (Debug, Info, Warnings, Errors). You may also save or clear the current log information.

Diagnostics Menu Examples

View App Log Form:

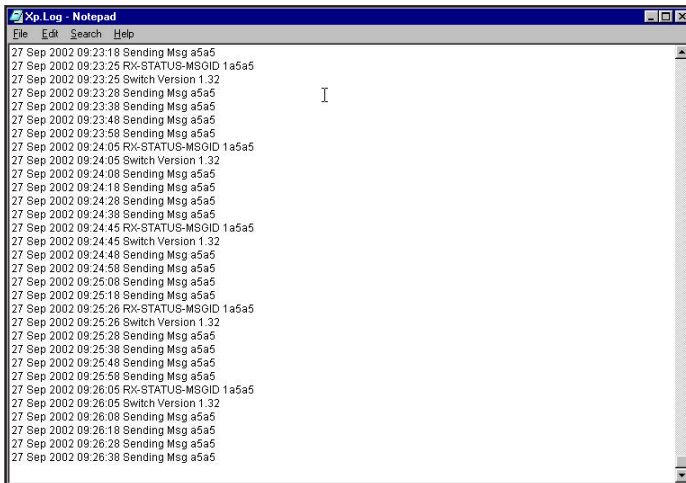

View AdvXP Status Form:

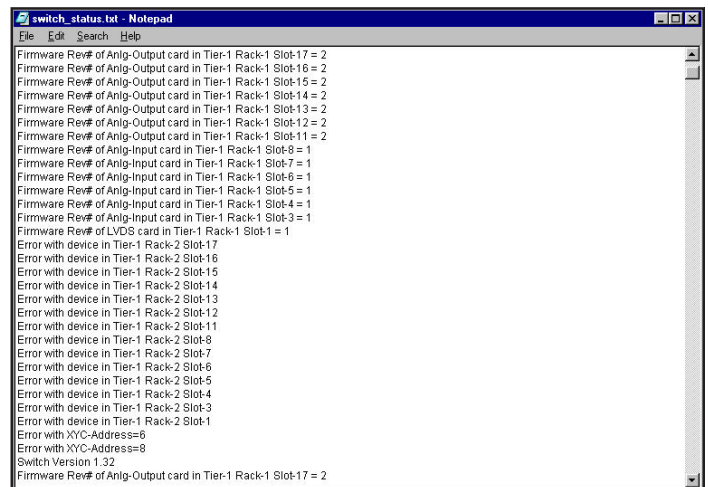

View TCP Form:

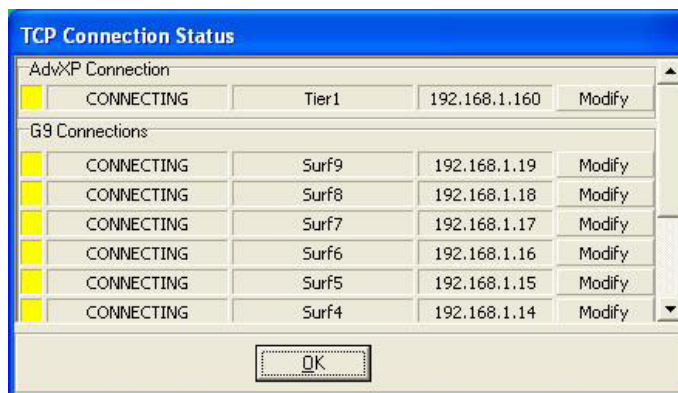

Setting Up an Air Tally with the Wheatstone GIBALTAR Router System

PURPOSE: Use the following procedure to set up an air tally logic output to be used to trigger an air tally light. All configuration is done using the Wheatstone XPoint GUI application.

PRELIMINARY: Before beginning the actual procedure you should read it through first and collect any information you need to know, such as location of logic cards, availability of logic ports, signal ID numbers of audio signals that you want to use for triggering the tally, etc.

Step 1 – Create a Logic Destination in the XPoint Matrix:

- This can be done at any unused destination signal ID, preferably below 1000
- For the sake of this discussion we will use signal ID number 1
- In the XPoint matrix right click on the first yellow box at the left under the word Destinations
- Select *Modify Signal Destination* from the popup menu to see the Signal Definitions dialog box
- The Id should be 1
- Enter a name, such as TheTally
- Destination will already be selected in the Source / Destination radio group
- Select *Logic I/O Only* from the radio group of signal types
- Select the *Logic I/O (1-6)* Tab and put a check under Enabled for LIO 1 (assuming it is not already in use)
- Select the Tier, Rack, and Slot where the Logic IO card you will use is located
- Select the port you want to use; I'll use 1 in my example
- Set *Direction* to Out (you use a logic OUTPUT port to provide the tally closure)
- Make sure the *Invert* box is unchecked
- From the drop-down Function list select ST4InUse (corresponds to CR tally in VDip)
- Click *Apply*

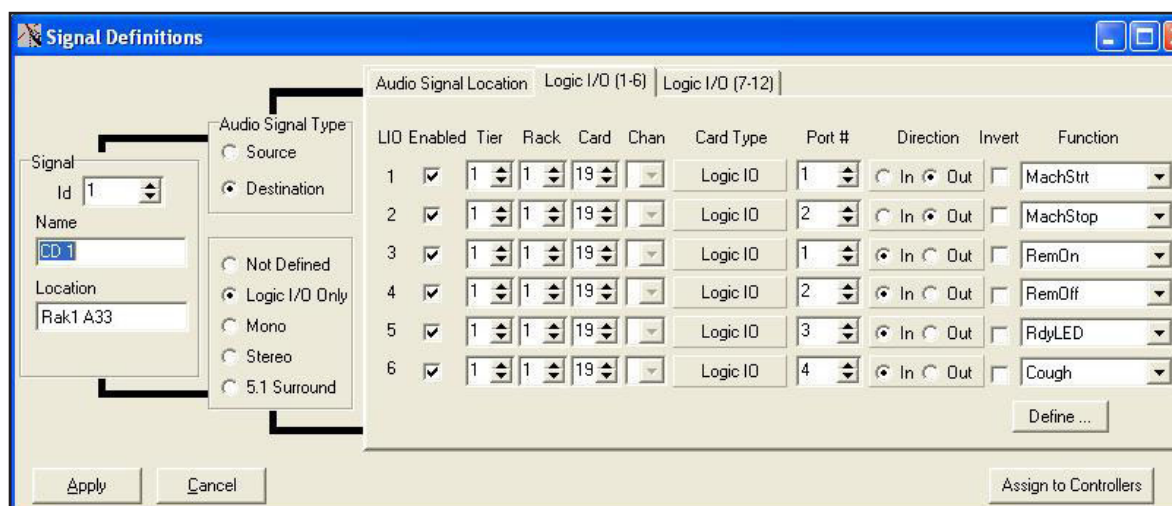

A brief explanation is in order here. There are 4 monitor circuits associated with most Wheatstone surfaces: Studio1, Studio2, Headphone, and Control Room. These appear in the VDip screen as Studio Tally's 1, 2, HP, and CR. They appear in the function list, when setting up a logic signal's function, as ST1InUse, ST2InUse, ST3InUse, and ST4InUse. This is why you use ST4InUse to set up a Control Room (CR) tally.

Step 2 – Modify the VDip Settings

Next you will need to make the VDip settings for the surface inputs you want to trigger the tally with. Please note that the VDip settings apply to an input SIGNAL, and not to a surface channel.

- Select the *Configure/VDip Settings* menu item in XPoint - defaults to Surf1 - select the actual surface you want to work with
- Unless you want the tally to activate whenever any surface channel is ON, select the *Per Signal Tab* - it will be helpful if you write down the signal ID numbers of the sources that will trigger the tally before you get to this point - for our example, assume the signals Mic1, Mic2, and Mic3 will be used, and that the signal IDs for these signals are 33, 34, and 35
- Highlight the *Input Signal Id* box entry (defaults to 1) and type 33 - the signal name of Mic1 is now also displayed
- Click *Override Defaults* - put a check mark in the Studio Tally box labeled CR
- Using the up arrow in the Id box, select 34 and repeat step 4 - and once more for Id 35
- Click *OK*.

Step 3 – Wire Up the Logic Port

Next, wire up the logic card's output port 1 to the external circuitry (usually a relay) that will activate the tally light itself. Refer to the *Hardware* chapter of this manual. In the subsection that deals with the Logic Input/Output Card (LIO-2001) there is a diagram that indicates how the external wiring is done (page 2-67). Output port 1 appears on pins 12 and 25 of the LOWER DB-25 connector (see page 2-74 for the pinouts).

Step 4 – Create a New Crosspoint

The only thing left to do is to create a crosspoint between the Destination just created (TheTally) and the auto-generated source signal that carries the tally functions for the surface. By auto-generated sources, we mean sources that are automatically generated by the XPoint program when a system is configured with one or more surfaces. These signals normally appear at signal ID 1000 and above. The names of these signals are of the form DxTALLY, where D tells us that the surface is in the D-series (a surface in the E-series would have a E in place of the D) and x is a number indicating which of (possibly) several surfaces this signal is specific to. This all assumes that you haven't renamed the surface. D xTALLY will be one of the last Sources seen for a particular surface. You may want to lock this crosspoint to prevent it from being accidentally disconnected.

This should be sufficient information for you to set up a Control Room or Studio tally.

Glossary

The terminology used in this manual is defined as follows.

- **Channel** – A single, monaural audio stream. The GIBALTAR can switch up to 512 discrete inputs to 512 discrete outputs (256 x 256 stereo) per tier.
- **Signal** – Information from a single audio source. A signal may take up one (mono), two (stereo), or six (5.1 surround sound) channels.
- **TDM** – Time Division Multiplex bus. The GIBALTAR backplane consists of 32 16xTDM busses (hereafter referred to as “TDMs”).
- **TDM Slot** – Each TDM bus has 16 multiplexed “slots” available, which can each carry one channel of audio data (i.e. single tier maximum of 512 mono TDM slots).
- **Chassis or Rack** – A single GIBALTAR backplane.
- **Local Rack** – Rack ID 4 or less.
- **Remote Rack** – Rack IDs greater than 4.
- **GUI** (pronounced “goo-eee”) – refers to the Windows XPoint program Graphical User Interface.
- **XYC GUI** – refers to the XPoint program running in XY controller mode.
- **Master Rack** – The first rack in a GIBALTAR router, which must contain the controlling CPU for the Router.
- **Slot** – A position within a rack where a single card is located.
- **Tier** – A single GIBALTAR router, which may consist of multiple remote and local chassis that are controlled by a single CPU card in the master chassis.
- **Multi-Tier** – A grouping of GIBALTAR routers connected in a “star” configuration. The CPU card in the Hub of the network computes how to connect signals between the individual tiers.
- **Hub Tier** – The central Router in a GIBALTAR Multi-Tier environment – not to be confused with an Ethernet Hub.
- **Satellite Tier** – One of up to fourteen GIBALTAR routers connected to the hub in Multi-Tier environment.
- **Salvo** – A logical grouping of connections that may be made by the operator via a single action (on the Configuration GUI, XYC GUI, or XY Controller).

The following terms apply to Router configuration.

- **Switch ID** – A unique identifier assigned to each GIBALTAR router. Used in multi-tier configurations (described below).
- **Rack ID** – The physical chassis ID number. The master chassis is always identified as Rack ID 1. The CPU card drives Rack ID onto the backplane. Audio Network cards also have a dipswitch that will drive the Rack ID when the card is configured for a remote rack. The Rack ID’s for remote racks must be in the range of 5 - 16. Note that Rack ID’s are zero based so that a dipswitch setting equal to ØØ is Rack ID 1, a dipswitch setting of Ø1 equals Rack ID 2, etc.

- **Slot ID** – The physical slot number in each chassis (numbered from 1-16). Backplane wiring defines a card’s slot ID. A CPU card must be in Rack ID 1, Slot ID 16.
- **TDM ID** – This indicates the TDM bus to be used. There are up to 32 TDMs in each chassis, labeled from 1-32.
- **TDM Slot ID** – Within each TDM there are up to 16 discrete channels which each take up one “slot” within the TDM bus. An Input card has 16 available channels that are mapped 1:1 to the available slots.
- **Channel ID** – Channel IDs within a chassis run from 0-511. Input Channel IDs are assigned consecutively across TDMs (i.e. TDM 0 has Channel IDs 1-16 on it, TDM 1 has Channel IDs 17-32, etc.). Output Channel IDs are assigned directly to the output devices.
- **Signal Type** – Each input and output in the GIBRALTAR is associated with a type of signal. These include mono, stereo, or surround sound. The importance of this information at configuration time is the number of channels each signal consumes. Mono signals use 1 channel; stereo uses 2; and surround sound uses 6.

Appendices

Appendix 1

Configuring System IP Addresses.....A-3

Appendix 2

Failover CPU Configuration and OperationA-7

Appendix 3

Replacement Parts List.....A-10

Appendix 1

Contents

Configuring System IP Addresses.....	A-3
--------------------------------------	-----

Configuring System IP Addresses

Caution! *Your system has been pre-configured at the factory for a default IP address of 192.168.1.160. Incorrect editing of network files will cause system malfunction. Check the IP address label inside the master rack before making changes. Please consult Wheatstone support if you are having trouble connecting your system to a network.*

NOTE: In this discussion of IP Addressing, any notes specifying the GIBRALTAR router also apply to the WHEATNET, if that is the main (Tier 1) controller in your system.

Overview

In order to communicate to the GIBRALTAR router over ethernet, appropriate network parameters must be loaded. Constraints on the router configuration were made to simplify the installation, while still providing the flexibility to connect the router to existing customer networks. They are:

1. The router and any attached GUIs must exist on the same subnet. The router has no ability to route across subnets.
2. If dynamic address allocation is used on the network (e.g. DHCP), the router must be given a “permanent” address allocation. In order to allow the router to run on simple networks or at sites with little system admin support, dynamic address allocation schemes (such as DHCP or BOOTP) were not used to provide an IP address to the router.

Editing Network Parameters

Both the GIBRALTAR router and control surfaces store their network IP address and subnet information in a simple text file on their respective flash hard disks. Changing the GIBRALTAR router’s network parameters requires the user to download the xp_net.txt file via FTP from *EACH* GIBRALTAR CPU, edit as required, then move each edited file back onto the respective CPU. Once the editing process is complete, a system re-boot will initialize the new addressing scheme.

Setting up FTP Site Profiles

Typical FTP clients allow the user to create Site Profiles for frequently visited FTP sites. These site profiles store log-on information and site location information that would otherwise have to be entered every time you access the site. Remember that *EACH* CPU in the system is a “site.” Required profile information is:

- Site Name – Identify the CPU you are connecting to (e.g. “GIBRALTAR Primary”)
- IP address of FTP site (GIBRALTAR default 192.168.1.160, Surface 1 = 192.168.1.11)
- User Name = knockknock (lower case)
- Password = whosthere (lower case)

Open the third party FTP application and create a site profile for the GIBRALTAR’s Primary CPU using the *current* IP address (default is 192.168.1.160). If your system has multiple CPU’s, and/or surfaces, go ahead and create site profiles for each device. This will make the retrieval, editing, and uploading process easier later on.

We recommend the freeware FTP client FileZilla. Windows Internet Explorer allows FTP, but in our experience it is not the best choice for this file maintenance application.

IP Addressing Scheme

All GIBRALTAR systems use the following IP addressing format:

For Tier1 Rack1:

Primary GIBRALTAR CPU: 192.168.1.160 (Slots 15 & 16)

Backup GIBRALTAR CPU: 192.168.1.161 (Slots 13 & 14)

For Multi Tier:

Tier2: 192.168.1.162, Tier3: 192.168.1.163, etc.

Note that multi tier systems may have all Tier IP addresses entered into the file regardless of whether or not CPU's are physically installed in Tiers 2 or higher.

Surfaces begin at 192.168.1.11.

Editing the Network Text Files

Note: It is very important to save the edited file on your PC. This can help in the event a typo prevents you from connecting after re-boot.

Once connected via FTP to the GIBRALTAR's flash hard drive you will see a directory listing of files and an FDOS folder.

- Locate the "xp_net.txt" file in the file list.
- Copy this file to your desktop.
- Edit the IP address(es) and subnet mask as required.
- Locally Save, then Copy the edited xp_net.txt file back onto the CPU.
- Repeat for EACH CPU in the system.
- Re-boot the system (Cycle power on all CPU racks and surfaces).
- Change your PC's IP address and the XPoint software IP address via the *Configure-AdvXP* form. All CPU's and the PC must be on the same subnet.

Sample network text files are included on the next page for reference.

Sample Bridge CPU Network Files

Primary GIBRALTAR CPU - xp_net.txt

```

NAME:PRIMARY          << 8 Character limit
TIERID:1              << Do NOT Edit - must match physical Tier location
NUMTIERS:5           << Do NOT Edit
IPADDR1:192.168.1.160 << Edit IP addresses as required
IPADDR2:192.168.1.162
IPADDR3:192.168.1.163
IPADDR4:192.168.1.164
IPADDR5:192.168.1.165
GATEWAY:255.255.255.255 << Do NOT Edit
SUBNET:255.255.255.0  << Edit Subnet mask as required
BCAST:55555          << Do NOT Edit
FAILIP:192.168.1.161 << Enter 0.0.0.0 if backup not installed

```

Backup GIBRALTAR CPU - xp_net.txt

NAME:Backup
 TIERID:1
 NUMTIERS:5
 IPADDR1:192.168.1.160
 IPADDR2:192.168.1.162
 IPADDR3:192.168.1.163
 IPADDR4:192.168.1.164
 IPADDR5:192.168.1.165
 GATEWAY:255.255.255.255
 SUBNET:255.255.255.0
 BCAST:55555
 FAILIP:192.168.1.161

<< Edit as required when Backup CPU present



Important Note: The Backup and MultiTier CPUs all use the same file as the Primary, the only differences are:

- **The backup CPU's file has a NAME: Backup entry;**
- **Multitier CPU's have different NAME: and TIERID: entries.**

Surface Network Files

Surface network files follow the same basic format as the GIBRALTAR. Note that the file name will begin with the model type (e.g. D8_net.txt, E6_net.txt, etc.)

NAME:Prod 7 << Up to 8 characters
 SURFID:1 << Do NOT Edit
 IPADDR:192.168.1.11 << Edit IP address as required
 FAILIPADDR:192.168.1.12 << See failover notes below
 SUBNET:255.255.255.0 << Edit subnet mask as required
 GATEWAY:255.255.255.255 << Do NOT edit

Surface Failover CPU Addressing Notes

Some surfaces are equipped with optional failover CPU's. Not all surfaces support failover CPU's and their net.txt files will not include this line. On surfaces that support failover, the FAILIPADDR: entry is typically the next sequential IP#. If a failover CPU is not present, enter 0.0.0.0 for the FAILIPADDR: parameter in the surface's primary CPU xx_net.txt file.

Appendix 2

Contents

Failover CPU Configuration and Operation	A-7
--	-----

Failover CPU Configuration and Operation

Overview

The GIBRALTAR may optionally incorporate a Failover CPU backup system. This system is designed to ease the transition back online in the event of a master CPU failure. Note that depending on the failure mode of the CPU the transition may or may not be fully automatic and may require intervention by the system engineer.

Software Requirements

Both CPU-2001 cards installed in the master chassis must have the same switch software and FPGA revisions installed on them.

Hardware Requirements

Two CPU-2001 modules must be installed in the master chassis of the system. The primary CPU card will be installed in Slot 16, the backup CPU will be installed in slot 14.

Ethernet Connections

Both the primary and backup CPU cards must be connected via ethernet to the same network and subnet. The CAT-5 cables used will be the “straight” version wired as described in the CPU-2001 chapter of this manual.

AES Sync

If you are synchronizing the GIBRALTAR to an external AES reference clock, be sure to make connections to both CPU’s AES SYNC inputs. Note, to ensure impedance matching, do not parallel the AES inputs or outputs. Instead, provide dedicated AES drivers/receivers.

Automatic Operation

In the unlikely event of a primary CPU failure the backup CPU is notified via backplane logic. System control is transferred to the Backup CPU. Switch requests from hardware or software controllers which happen to occur during the transition time will be ignored and lost. Master clock backplane signals are automatically switched to originate from the backup CPU oscillator (or optional AES sync), thereby providing continuous operation of audio.

In order to insure that the backup CPU always has the most current configuration, it is imperative that both CPUs have a good connection via their Ethernet ports, to the Wheatstone network. Current configuration, including the status of all crosspoint connections, is transferred from the main CPU to the backup CPU on a recurring basis.

Appendix 3

Contents

Replacement Parts List.....	A-10
-----------------------------	------

For the most part there are no user-replaceable parts in the GIBRALTAR cage. A complete list of available components is shown on the next page. Contact Wheatstone technical support for further information.

Wheatstone Corporation (600 Industrial Drive, New Bern, North Carolina, USA 28562) may be reached by phone at 252-638-7000, fax 252-637-1285, electronic mail “techsupport@wheatstone.com”.

REPLACEMENT PARTS – GIBRALTAR ROUTER

COMPONENT	DESCRIPTION	WS P/N
AES-2024/8	DIGITAL 8 INPUT CARD	008312
AES-2024/16	DIGITAL 16 INPUT CARD	008313
DO-2016/8	DIGITAL 8 OUTPUT CARD	008303
DO-2016	DIGITAL 16 OUTPUT CARD	008309
ADI-2001	ANALOG INPUT CARD	008306
AO-2001	ANALOG OUTPUT CARD	008308
MIC-2001	ANALOG MIC INPUT/OUTPUT CARD	008316
HC-2001	HOST CONTROLLER CARD (CPU)	008302
HC-2001-RNC	HOST CONTROLLER CARD WITHOUT COMPUTER	008393
QAT-2001	QUAD AUDIO NETWORK CARD	008314
DSP-2001	DIGITAL SIGNAL PROCESSOR CARD WITH DRAM MEMORY FOR DELAY	008310
DSP-2001ND	DIGITAL SIGNAL PROCESSOR CARD WITH DRAM	008315
DSP-2009M	MIX ENGINE DIGITAL SIGNAL PROCESSOR CARD	008318
DSP-2009EQ	MIX ENGINE DIGITAL SIGNAL PROCESSOR CARD	008391
LIO-2001	LOGIC INPUT/OUTPUT CARD	008311
SDI-2001	SERIAL DIGITAL INTERFACE CARD	008897
MADI-2001	MULTICHANNEL AUDIO DIGITAL INTERFACE CARD	008898
MB-FR	MOTHERBOARD CARD	010620
2DB-2001	COMPLETE REAR PANEL WITH TWO DB-25 CONNECTORS	008340
DB-2001	COMPLETE REAR PANEL WITH ONE DB-25 CONNECTOR	008346
8BNC-2001	COMPLETE REAR PANEL WITH EIGHT BNC CONNECTORS	008345
8RJ-2001	COMPLETE REAR PANEL WITH EIGHT RJ-45 CONNECTORS	008344
QCT-2001	COMPLETE REAR PANEL FOR CAT5 CONNECTIONS	008349
QOT-2001	COMPLETE REAR PANEL FOR OPTICAL FIBER CONNECTIONS	008387
QFT-2001	COMPLETE REAR PANEL FOR OPTICAL FIBER CONNECTIONS	008665
GNE-HCI-2001	COMPLETE REAR PANEL FOR DARS & ETHERNET CONNECTIONS	010621
LRJ-2001	COMPLETE REAR PANEL WITH RJ CONNECTORS FOR MIC LOGIC CONNECTIONS	008653
SDIIF-2001	COMPLETE REAR PANEL FOR SERIAL DIGITAL VIDEO INTERFACE	008895
MADIIF-2001	COMPLETE REAR PANEL FOR MULTICHANNEL DIGITAL AUDIO INTERFACE	008893
BK-2001	BLANK REAR PANEL	008339
POWER SUPPLY	POWER SUPPLY FOR GIBRALTAR UNIT	007390
POWER CORD	7-1/2" BLACK POWER CORD	150017
SOFTWARE	XPOINT SOFTWARE CD	071792
CONNECTOR KIT	CONNECTOR KIT FOR ROUTER	008398
MANUAL	OWNER'S MANUAL	010699